

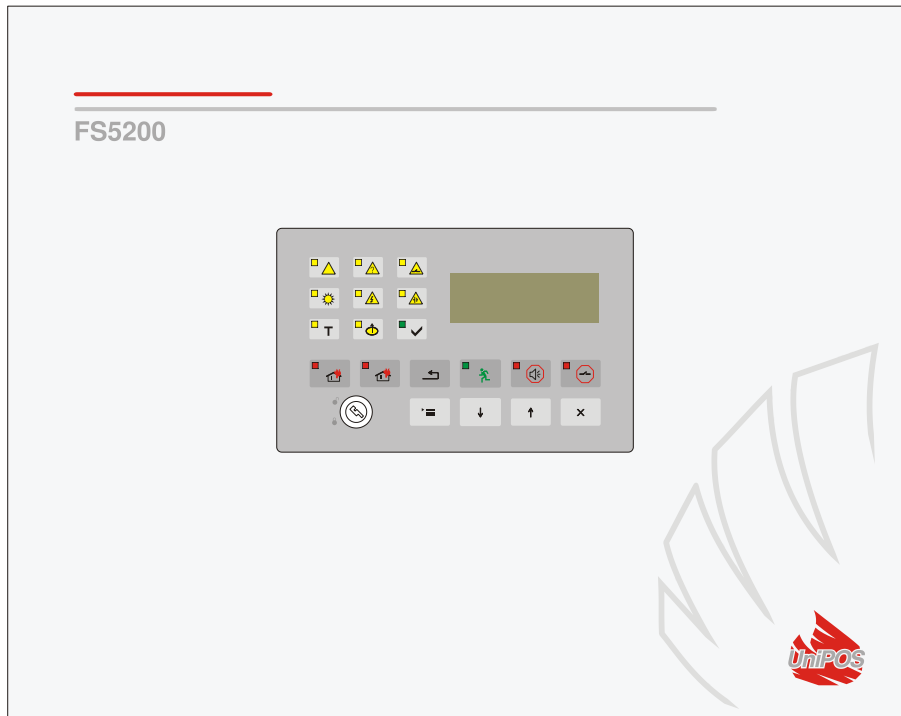

Fire Control Panel FS5200



INSTRUCTION MANUAL

Revision 8/07.17

Content

1. Introduction	5
2. Terminology	5
3. Function	7
4. Technical data	7
4.1. Modules	7
4.1.1. Type of modules.....	7
4.1.2. Basic module.....	7
4.1.3. Additional module.....	7
4.2. Physical configuration	8
4.3. Fire alarm lines	9
4.4. Controllable outputs	9
4.5. Common purpose relay outputs	9
4.6. Relay output for fault conditions	9
4.7. Performance	9
4.8. Indications of registered events	10
4.9. Power supply	10
4.9.1. Mains.....	10
4.9.2. Backup batteries	10
4.9.3. Consumption on backup batteries supply.....	10
4.9.4. Power supply to external devices	10
4.10. Dimensions	11
4.11. Weight	11
5. Contents of delivery	11
5.1. Fire control panel	11
5.2. Additional module	11
5.3. Module 5201	11
5.4. Module 5203 or 5204	11
6. General information	11
6.1. Access levels	11
6.1.1. Access level 1.....	11
6.1.2. Access level 2.....	12
6.1.3. Access level 3.....	12
6.1.4. Access level 4.....	12
6.2. Indications and buttons for control	12
6.3. Function <i>Logical AND</i> of two lines	12
6.4. Conditions of the fire control panel	15
7. Duty Mode	15
7.1. Description	15
7.2. Indication	15
7.2.1. LED and sound indication.....	15
7.2.2. Text message.....	15
7.3. Using the keypad	15

8. Fire condition	15
8.1. Description	15
8.2. Indication	16
8.2.1. LED and sound indication	16
8.2.2. Text message	16
8.3. Using the keypad	17
9. Pre-Fire condition	18
9.1. Description	18
9.2. Indication	18
9.2.1. LED and sound indication	18
9.2.2. Text message	18
9.3. Using the keypad	18
10. Fault condition	19
10.1. Description	19
10.2. Indication	20
10.2.1. LED and sound indication	20
10.2.2. Text messages	20
10.3. Using the keypad	23
11. Disabled Component Mode	23
11.1. Description	23
11.2. Indication	24
11.2.1. LED and sound indication	24
11.2.2. Text messages	24
11.3. Using the keypad	24
12. Test Mode	24
12.1. Description	24
12.2. Indication	24
12.2.1. LED and sound indication	24
12.2.2. Text messages	24
12.3. Using the keypad	25
13. Information and Control Mode	25
13.1. Description	25
13.2. Menu Faults	26
13.3. Menu Disabled components	26
13.4. Menu Lines in test	27
13.5. Menu Status	27
13.6. Menu Pre-Fire condition	28
13.7. Menu System functions	28
13.7.1. Function <i>LED and sound indicators check up</i>	28
13.7.2. Menu <i>Current in fire alarm lines</i>	29
13.7.3. Menu <i>Mode</i>	29
13.7.4. Menu <i>Setting the clock</i>	29
13.7.5. Menu <i>Fire alarm lines test</i>	31
13.7.6. Menu <i>Disable fire alarm lines</i>	31
13.7.7. Menu <i>Disable controllable outputs</i>	32

13.7.8. Menu <i>Parameter review</i>	32
13.7.9. Menu <i>Set Parameters</i>	36
13.7.10. Menu <i>Archive review</i>	36
14. <i>SetUp Mode</i>	38
14.1. Description	38
14.2. Access to SetUp Mode	39
14.3. Menus	40
14.3.1. Menu <i>Line parameters</i>	40
14.3.2. Menu <i>Fire control panel parameters</i>	43
14.3.3. Menu <i>Adjustment of controllable outputs</i>	44
14.3.4. Menu <i>Adjustment of relay outputs</i>	44
14.3.5. Function <i>Default parameters</i>	45
14.3.6. Function <i>Clear archive</i>	45
14.3.7. Function <i>Enter new password</i>	46
15. <i>Remote Control Mode</i>	46
15.1. Description	46
15.2. Indication	46
15.2.1. LED and sound indication	46
15.2.2. Text message	46
15.3. Using the keypad	46
16. <i>Saving the parameters</i>	46
17. <i>Labour protection requirements</i>	47
18. <i>Installation and arrangements</i>	47
18.1. To mount the fire control panel	47
18.2. Periphery devices assembly	47
18.2.1. Mounting periphery devices to controllable outputs	47
18.2.2. Mounting periphery devices to relay outputs	47
18.3. Connecting interface units	47
18.4. Connecting fire detectors	48
18.5. Connection to power supply	48
19. <i>Fire control panel start up</i>	48
20. <i>Change in fire control panel configuration</i>	49
20.1. How to add or remove Additional Module	49
20.2. Change in Basic Module	49
20.3. Changes in Additional Module	50
21. <i>Troubleshooting</i>	51
22. <i>Conditions of operation, storage and transportation</i>	53
22.1. Operation and storage	53
22.1.1. Temperature	53
22.1.2. Relative humidity	53
22.2. Transportation	53
23. <i>Warranty</i>	53
24. <i>Appendixes</i>	54

1. Introduction

Fire Control Panel FS 5200 is a modern, highly reliable, multifunctional and versatile unit, providing the user with unexpected potential in the design, installation and operation of conventional fire alarm systems.

Some of its main features and possibilities are:

- Adjustment of operating modes and parameters of each fire alarm line via built in keypad;
- User oriented menu dialogue for easy and convenient operation;
- LCD for visualization of system checkup and setup modes;
- LEDs indication for early warning of a break down or extreme conditions;
- Ability to address automatic fire detectors and manual call points in groups;
- Energy independent archive memory saving the event type, date and time, allowing for detailed analysis of the actions of the authorized personnel and of possible problems in the fire protection process of the area;
- User oriented test modes allowing for a total control of the site protected;
- Built-in serial interface for connection to second level control devices, ability for connection via telephone line and standard modem;
- System expansion and functional modification (our goal is discontinuous improvement of the fire alarm equipment features), no additional cabling necessary;
- Compatible to random installation design, within the range of fire control panels resources.

All these are realizable via fire control panel's keypad and after a detailed examination of the instructions set herewith.

2. Terminology

ACCESS LEVEL – access level to various indications and control functions (see section 6.1).

ASSOCIATED OUTPUT – *controllable or relay output*, programmed by user to react (separately in Fire condition I and Fire condition II) in Fire condition via selected *fire alarm line*.

CONTROLLABLE OUTPUT – potential output that monitors the serviceability of the connection wires between the fire control panel and the executing device. Follow the special diagram for connection (Appendix 5 c).

DISABLED CONTROLLABLE OUTPUT – *the controllable output* is switched off (executing devices can not be activated) and is not monitored for a fault condition. This feature is user defined. The indication for a disabled controllable output includes common light indication and text messages on the LCD display.

DISABLED LINE – a switched off line, without power supply, not controlled for activated fire detectors and fault condition. This condition is user defined. The indication for a disabled line includes common light indication and text messages on the LCD display.

FATAL FAULT CONDITION – fault condition that does not allow the fire control panel or the part providing communication with the user, to continue operation. The fatal fault condition is a System fault, except for *Battery Low*. The indication is common light indication, local sound indication and text messages on the LCD display.

FIRE ALARM LINE (further on it will be referred as **LINE**) – a combination of automatic fire detectors and manual call points, physically connected by the means of two-wire connection. The basic configuration of FS 5200 includes 8 lines; the maximum configuration includes 32 lines. Up to 32 fire detectors can be integrated into one line.

FIRE CONDITION STAGE I – upon activation of automatic fire detector the fire control panel enters Fire condition, phase Fire condition stage I until the defined time expires. The common and local light indicators, local sound signaling and a text message displayed on the LCD display indicate the phase.

FIRE CONDITION STAGE II – the fire control panel enters Fire condition, phase Fire condition stage II when: a) the time for *Fire condition stage I* has expired or b) upon activation of a manual call point. The common and local light indicators, local sound signaling and a text message displayed on the LCD display indicate the phase.

FUNCTION “LOGICAL AND” OF TWO LINES – function that allows the fire control panel to enter *Fire condition stage I* in two *lines* upon simultaneous activation of automatic fire detectors (see section 6.3)

GROUNDING – non-system *non-fatal fault condition*, due to leakage to a grounded wire.

GROUP ADDRESSING – fire control panel’s ability to make a difference between activation of automatic fire detector and manual call point, which are in one and the same *fire alarm line*. For this purpose the manual call points’ current consumption value shall exceed the threshold value for *Fire condition stage II*.

INSPECTION TIME – period of time added to the remaining time, before the system proceeds from *Fire condition stage I* to *Fire condition stage II*, when button  is pressed. Usually, this period of time is long enough for the authorized personnel to check up the indicated premises. The inspection time is user defined and is equal for all *fire alarm lines*. Light indicators show adding a period of time for inspection.

INTERRUPTED LINE OR CONTROLLABLE OUTPUT – non-system *non-fatal fault condition* due to current value in a line or in a controllable output lower than the threshold value. The user shall define the threshold value separately for each line.

LINE IN TEST – *line* set by the user to Test condition. The line is powered and reset (the power is cut off for 3 s) periodically every 64 s. The events registered in a line in Test condition are not saved in the archive and do not trigger the associated outputs nor the light and sound signaling. The indication for a line in Test condition is common light indication.

LINE STATUS OR CONTROLLABLE OUTPUT STATUS – current status of a *line* or a *controllable output*: normal status; fire conditions stage I or II (for a line only); fault condition and its type.



LOCAL SOUNDER - sounder built-in the fire control panel.

LOW BATTERY – non-system *fatal fault condition* due to full discharge of the backup batteries upon interrupted power supply.

NEW CONFIGURATION – a system *fatal fault condition* due to detected conflict between the current physical configuration and the configuration saved in the memory. Usually it occurs when a module has been added, removed or replaced. In such case adjust the settings in the fire control panel.

NON-FATAL FAULT CONDITION – fault condition that allows the fire control panel to continue operation. A non-fatal fault condition is usually a *non-system* fault condition. The indication is common light indication, local sound indication and text messages on the LCD display.

PRE-FIRE CONDITION – condition of the fire control panel used by the function *Logical AND of two lines* to provide control over simultaneous response of automatic fire detectors in the *lines*. (see section 6.3)

PROCEEDING FROM FIRE CONDITION STAGE I TO FIRE CONDITION STAGE II – the time is user defined for each *fire alarm line* separately. During the phase *Fire condition stage I* the remaining time for the selected fire alarm line is indicated on the LCD display. During the remaining time actions can be taken, for example press  or .

RELAY OUTPUT – relay, potential free, switching outputs that control external executive devices.

REMOVED FIRE DETECTOR – non-system *non-fatal fault condition* due to removed fire detector in a *line*. To use this function, the fire detectors shall be connected as in Appendix 5 a.

SHORT CIRCUIT IN A LINE OR IN A CONTROLLABLE OUTPUT – non-system *non-fatal fault condition* due to registered current value in a *line* or in a *controllable output* that exceeds a specified threshold value. The threshold value for each line shall be user defined.

SUPRESSED OUTPUT – *controllable* or *relay* output which should normally be activated (the fire alarm line is in the relevant phase Fire condition) but is manually switched off by the user.

SYSTEM FAULT – *fatal fault condition* due to a fault in a basic component of the fire control panel (or system). The System fault may be a *fatal error* or a *non-fatal error*. The event is indicated by common light indicators, local sound signaling and a text message displayed on the LCD display.

SYSTEM OPERATION – the fire control panel executes internal operations to set its registers. This is visualized on the LCD display with a text message for system operations, before the user is allowed to proceed with his work with FS 5200.

3. Function

Fire control panel FS5200 is designed to operate with conventional automatic fire detectors and manual call points. The panel has outputs provided for external executive devices. Its modular structure allows for variable configurations according the specific features of the protected site

4. Technical data

4.1. Modules

4.1.1. Type of modules

- Basic module
- Additional module
- Power supply module

4.1.2. Basic module

- Basic module
(Circuit Board 5200Basic and 5200Indication) - 1 controllable output
- 2 relay outputs for fire condition
- 1 relay output for fault conditions
- Expansion
 - ◆ Module 5201 - 8 lines
 - ◆ Module 5203 - 8 relay outputs for fire condition
 - ◆ Module 5204 - 16 relay outputs for fire condition

Note: The Basic Module can not be expanded with Module 5203 and Module 5204 at the same time – you may insert only one of them.

4.1.3. Additional module

- Module 5202 - 8 lines
- 1 controllable output
- Expansion
 - ◆ Module 5201 - 8 lines

4.2. Physical configuration

Configuration	Modules						Technical data
	Basic			Additional			
	Basic Module	Module 5201	Module 5203	Module 5204	Module 5202	Module 5201	
00 (Configuration minimum)	x						<ul style="list-style-type: none"> ▪ 8 lines ▪ 2 relay outputs for fire condition ▪ 1 controllable output ▪ 1 relay output for fault condition
01	x		x				<ul style="list-style-type: none"> ▪ 8 lines ▪ 10 relay outputs for fire condition ▪ 1 controllable output ▪ 1 relay output for fault condition
02	x			x			<ul style="list-style-type: none"> ▪ 8 lines ▪ 18 relay outputs for fire condition ▪ 1 controllable output ▪ 1 relay output for fault condition
03	x	x					<ul style="list-style-type: none"> ▪ 16 lines ▪ 2 relay outputs for fire condition ▪ 1 controllable output ▪ 1 relay output for fault condition
04	x	x	x				<ul style="list-style-type: none"> ▪ 16 lines ▪ 10 relay outputs for fire condition ▪ 1 controllable output ▪ 1 relay output for fault condition
05	x	x		x			<ul style="list-style-type: none"> ▪ 16 lines ▪ 18 relay outputs for fire condition ▪ 1 controllable output ▪ 1 relay output for fault condition
06	x	x			x		<ul style="list-style-type: none"> ▪ 24 lines ▪ 2 relay outputs for fire condition ▪ 2 controllable outputs ▪ 1 relay output for fault condition
07	x	x	x		x		<ul style="list-style-type: none"> ▪ 24 lines ▪ 10 relay outputs for fire condition ▪ 2 controllable outputs ▪ 1 relay output for fault condition
08	x	x		x	x		<ul style="list-style-type: none"> ▪ 24 lines ▪ 18 relay outputs for fire condition ▪ 2 controllable outputs ▪ 1 relay output for fault condition

Configuration	Modules						Technical data
	Basic				Additional		
	Basic Module	Module 5201	Module 5203	Module 5204	Module 5202	Module 5201	
09	x	x			x	x	<ul style="list-style-type: none"> ▪ 32 lines ▪ 2 relay outputs for fire condition ▪ 2 controllable outputs ▪ 1 relay output for fault condition
10	x	x	x		x	x	<ul style="list-style-type: none"> ▪ 32 lines ▪ 10 relay outputs for fire condition ▪ 2 controllable outputs ▪ 1 relay output for fault condition
11 (Configuration maximum)	x	x		x	x	x	<ul style="list-style-type: none"> ▪ 32 lines ▪ 18 relay outputs for fire condition ▪ 2 controllable outputs ▪ 1 relay output for fault condition

All configurations include Power Supply Module.

Per customer request Interface Module and Modem Supply Module can be included in each configuration.

4.3. Fire alarm lines

- Maximum number of fire detectors in a line - 32
- Connecting line - two-wire
- Maximum resistance of a line - 100Ω
- Output resistance of a line - 164Ω

4.4. Controllable outputs

- Type - potential
- Electrical characteristics - (24±5)V/500mA

4.5. Common purpose relay outputs

- Type - potential free, switching
- Electrical characteristics - 3A/125VAC; 3A/30VDC

4.6. Relay output for fault conditions

- Type - potential free, switching
- Electrical characteristics - 3A/125VAC; 3A/30VDC

4.7. Performance

- Control over fire alarm lines and controllable outputs for fault conditions (short circuit and interruption) and automatic reset.
- Detection of removed fire detector and automatic reset.
- Ability to set the lines in dependency of the function "Logical AND"
- Group addressing of manual call points and automatic fire detectors
- Two phases of Fire condition, programmable time for Fire condition stage I, separately for each line

- Option to prolong the time period for Fire condition stage I with programmable overall inspection period
- Built-in sounder for fire condition – one tonal, continuous, can be switched off
- Built-in sounder for fault condition – one tonal, discontinuous, can be switched off
- Built-in real time clock
- Set of test modes and options for adjustment :
 - ◆ Setting the clock;
 - ◆ Check up of light and sound indications;
 - ◆ Test of fire alarm lines;
 - ◆ Adjustment of outputs and the integrated external devices;
 - ◆ Measuring the current value in the fire alarm lines;
 - ◆ Programming of parameters and modes of operation;
 - ◆ Remote programming of the parameters from a distant operator control point.
- Energy independent archive of registered events with the events type, date and hour – up to 2500 events
- Communication interface for external devices - RS-232 (directly or via modem) or RS-485.

4.8. Indications of registered events

- Light indication - LED
- Text messages - LCD display -
4 lines x 20 symbols each,
Latin/Cyrillic characters, backlit
- Sound - built-in sounder

4.9. Power supply

4.9.1. Mains

- voltage - 220/230V
- frequency - 50Hz

4.9.2. Backup batteries

- battery type - lead, gel electrolyte
- number of batteries - 2 pcs
- connection - serial connection
- nominal voltage of the backup battery - 24V
- nominal capacity C_{20} - 12Ah
- extreme discharge voltage - 21V
- charge voltage - 28,2V

4.9.3. Consumption on backup batteries supply

- Configuration 00 - < 155mA at 24V
- < 150mA at 26V
- Configuration 03 - < 235mA at 24V
- < 225mA at 26V
- Configuration 06 - < 320mA at 24V
- < 305mA at 26V
- Configuration 09 - < 400mA at 24V
- < 380mA at 26V

4.9.4. Power supply to external devices

- voltage - (24±5)V
- maximum current value (including current of controllable outputs) - 1,5A

- 4.10. Dimensions
 - dimensions - 450x355x115mm
- 4.11. Weight
 - Backup batteries not included - 6,6kg

5. Contents of delivery

- 5.1. Fire control panel
 - Fire control panel FS5200 - 1 pc
 - Resistors 3,9k Ω / 0,25W - 8 pcs
 - Resistors 5,6k Ω / 0,25W - 1 pc
 - Jumper for the backup batteries - 1 pc
 - Fuse 4A - 2 pcs
 - Instruction manual - 1 pc
 - Instruction for the authorized staff - 1 pc
 - Packing - 1 pc
- 5.2. Additional module
 - Additional module - 1 pc
 - Ribbon cable - 1 pc
 - Earthing cable - 1 pc
 - Resistors 3,9k Ω / 0,25W - 8 pcs
 - Resistor 5,6k Ω / 0,25W - 1 pc
 - Special nut - 1 pc
 - Packing - 1 pc
- 5.3. Module 5201
 - Module 5201 - 1 pc
 - Resistors 3,9k Ω / 0,25W - 8 pcs
 - Screw M3 - 2 pcs
 - Plain washer M3 - 2 pcs
 - Spring lock washer M3 - 2 pcs
 - Packing - 1 pc
- 5.4. Module 5203 or 5204
 - Module 5203 or 5204 - 1 pc
 - Screw M3 - 2 pcs
 - Plain washer M3 - 2 pcs
 - Spring lock washer M3 - 2 pcs
 - Packing - 1 pc

6. General information

6.1. Access levels

There are 4 levels of access to the variable indications and control functions of FS5200.

6.1.1. Access level 1

All persons who would presumably find out and react to alarm for fault condition or fire condition have access to level 1.

The following features are accessible:

- Displaying suppressed messages for Fire condition, Pre-fire condition, Fault condition and Disabled components (see sections 8, 9, 10 and 11);
- Entering inspection time period (see section 8);
- Forced proceeding from phase Fire condition stage I to phase Fire condition stage II (see section 8);
- Suppressing the local sounder (see sections 8, 9 and 10);
- Displaying the status of the lines and of the controllable outputs (see section 13).

All light indicators are visible.

6.1.2. Access level 2

Level 2 is for the personnel in charge for the fire protection; they shall be trained and authorized to operate the fire control panel in the following conditions:

- Duty Mode;
- Fire condition;
- Pre-Fire condition;
- Fault condition;
- Disabled component;
- Information and adjustment.

To enter Access level 2, insert the key into the front panel in position .

The following features of the fire control panel are accessible:

- All features accessible at Level 1;
- Switching off the outputs, activated upon fire condition (see sections 8, 9 and 10);
- Exit of Fire condition (see section 8);
- System functions of the fire control panel without entering SetUp Mode (see section 13).

6.1.3. Access level 3

Accessible for personnel trained and authorized to:

- Reconfigure specific data – of the protected site or of the fire control panel – saved in the memory;
- Maintain the fire control panel.

This level has two sublevels of access - 3A and 3B.

Level 3, sublevel 3A, is accessed through a password, entered at Access level 2. At this sublevel the functions for reconfiguration of specific data for the protected site or the fire control panel are accessible (see section 14).

Level 3, sublevel 3B is accessed when the fire control panel is opened. The following features are accessible:

- Replacing a burnt fuse;
- Adding, removing and replacing a module;
- Connecting fire alarm lines and executive devices.

6.1.4. Access level 4

Accessible for personnel trained and authorized by the Producer to repair the fire control panel and to modify the software. Special means are required for access to this level.

6.2. Indications and buttons for control

Table 1 gives detail description of the indications for each status, Table 2 presents the basic means for control. Appendix 1 shows the front panel of Fire control panel FS5200 with its visual system for indication and control.

6.3. Function *Logical AND* of two lines

The function *Logical AND* gives the opportunity to set the following dependence between two lines in one and the same module (Basic module or Additional module): the fire control panel will enter Fire condition, phase Fire condition stage I, in each of the line (or in both of them) upon activation of fire detectors in both lines.

The function does not affect manual call points. Upon activation of a manual call point (value of the line current between Fire condition stage II and Short circuit) in a line, dependent on function “Logical AND”, the fire control panel will enter Fire condition stage II in this line.

Upon activation of automatic fire detector (value of the line current between Fire condition stage I and Fire condition stage II) in a line that is in Logical AND dependency by another line, the fire control panel will enter

- Pre-Fire condition in this line – if there is no activated automatic fire detector or manual call point in the other line;
- Fire condition, phase Fire condition stage I in this line – if there is an activated manual call point in the other line, i.e. the fire control panel has already entered Fire condition, phase Fire condition stage II in the other line;

- Fire condition stage I in both lines – if there is an activated automatic fire detector in the other line, i.e. the fire control panel has already entered Pre-Fire condition in the other line.

Exit from Pre-Fire condition in a line is done automatically only:

- Upon activation of automatic fire detector in a line that has settled “Logical AND” dependence to a particular line, within 60 s after entering Pre-Fire condition, the fire control panel enters Fire condition stage I in both lines;
- Upon activation of manual call point in the line that has settled dependence to a particular line according the function “Logical AND”, within 60 s after entering Pre-Fire condition, the fire control panel enters Fire condition stage I in this particular line, and Fire condition stage II in the first line;

Table 1

























Conditions of the fire control panel	Indication
All conditions - The fire control panel is power supplied	 Indicator <i>Power supply</i> – continuous green light
All conditions	 Indicator <i>Day Mode</i> – continuous yellow light
Fire condition, phase Fire condition stage I	 Common indicator <i>Fire condition stage I</i> – flashing red light
Fire condition, phase Fire condition stage II	 Common indicator <i>Fire condition stage II</i> – flashing red light
Fire condition, phase Fire condition stage I – inspection time has been entered	 Indicator <i>Inspection</i> – continuous green light
Fire condition and Fault condition - sounders have been suppressed	 Indicator <i>Stop Alarm</i> – continuous red light
Fire condition - outputs for fire condition have been suppressed	 Indicator <i>Suppressed outputs</i> - continuous red light
Fault condition - All faults except for Low battery	 Common indicator <i>Fault condition</i> – flashing yellow light
Fault condition – System fault and New configuration	 Indicator <i>System fault</i> – continuous yellow light
Fault condition - Fault in mains supply	 Indicator <i>Fault in mains supply</i> - flashing yellow light
Fault condition - Fault in the backup batteries or in the charger	 Indicator <i>Backup battery fault</i> - flashing yellow light
Fault condition - Fault in a controllable output	 Indicator <i>Out of order/Disabled controllable output</i> – flashing yellow light
Disabled component - Disabled controllable output	 Indicator <i>Out of order/Disabled controllable output</i> – continuous yellow light
Disabled component - Disabled line or controllable output	 Indicator <i>Disabled component</i> - continuous yellow light
Test condition	 Indicator <i>Test</i> – continuous yellow light
Fire condition	Local sounder – continuous signal
Pre-Fire condition	Local sounder – discontinuous signal: 4 sound impulses for 1s, followed by 1s break
Fault condition - All faults except for Low battery	Local sounder – discontinuous signal: 1s sound 1s break
Fault condition - Low battery	Local sounder – discontinuous signal: 1s sound 3s break

Table 2

Means of control	Condition of the fire control panel	Access level	Operation
Key for access to Level 2		Level 1	Position 
		Level 2	Position 
Button <i>Reset of line</i> 	Fire condition	Level 2	To exit Fire condition in a line, indicated on the LDC display
Button <i>Outputs</i> 	Fire condition, phase Fire condition stage I	Level 1	To force proceeding to phase Fire condition stage II
	Fire condition, phase Fire condition stage I	Level 2	- if activated outputs for fire condition are available – to suppress the outputs; - if no activated outputs for fire condition are available – to force proceeding to phase Fire condition stage II
	Fire condition, phase Fire condition stage II	Level 2	- if activated outputs for fire condition are available – to suppress the outputs; - if activated outputs for fire condition are not available – to activate any suppressed outputs
Button <i>Inspection</i> 	Fire condition, phase Fire condition stage I	Levels 1 and 2	To add inspection time
Button <i>Alarm</i> 	Fire condition and Fault condition*	Level 1	To suppress /activate the local sounder
Button <i>Menu</i> 	Duty Mode, Fire condition, Pre-fire condition, Fault condition*, Test mode and Disabled component	Levels 1 and 2	To enter Information and Control mode
	Information and Control	Levels 1 and 2	- To enter the selected menu - To execute the selected command
	SetUp	Level 3A	- To save a modified parameter
Button <i>Down</i> 	Fire condition	Levels 1 and 2	To display the next message for fire condition
	Information and Control	Levels 1 and 2	- To display the next element of the menu - To move the cursor
	SetUp	Level 3A	- To modify the selected parameter
Button <i>Up</i> 	Fire condition	Levels 1 and 2	To display the previous message for fire condition
	Information and Control	Levels 1 and 2	- To display the previous element of the menu;
	SetUp	Level 3A	- To modify the selected parameter
Button <i>Cancel</i> 	Information and Control	Levels 1 and 2	- To exit a function without saving changes in the parameter; the command will not be executed
	SetUp	Level 3A	- To exit the current menu and to move to an upper hierarchy menu

* Not effective in Fault condition (fatal fault condition except for New configuration).

- Upon increased current value in a line within the limits between current values for Fire condition stage II and Short circuit the fire control panel enters Fire condition stage II in this line;
- Where the 60 s of Pre-Fire condition expire and none of the above mentioned three conditions is carried out, the fire control panel exits Pre-Fire condition in this line and the line is reset – the power supply is interrupted for 3 s thus the activated automatic fire detectors in this line shall be reset.

To settle dependence of two lines on function “Logical AND”, set the parameter “Logical AND” in one of the lines (see section 14.3.1).

When using the “Logical AND” in two lines, we recommend one of the two methods:

- Outputs for fire condition shall be associated to one line only, where manual call points, if necessary, are already integrated;
- The same outputs for fire condition shall be associated to both lines (equal for both Fire condition stage I and II); in this case manual call points can be integrated in both lines.

6.4. Conditions of the fire control panel

FS5200 monitors the fire alarm lines by consecutively scanning their condition. Depending on the current value, the line can be in normal condition, in fire condition or in a fault condition (short circuit or break). Simultaneously, a constant control over the controllable outputs of fault condition (short circuit or break) is being carried out.

The fire control panel FS5200 operates in nine basic modes: Duty Mode, Fire Condition, Pre-Fire Condition, Fault Condition, Disabled Component Mode, Test Mode, Information and Control Mode, SetUp Mode and Remote Control Mode.

In each moment the control panel can be in one or in a random combination of these conditions: Fire Condition, Pre-Fire Condition, Fault Condition, Disabled Component Mode, Test Mode and Information and Control Mode, .Duty Mode, SetUp Mode and Remote Control Mode cannot be combined with another condition:

- The fire control panel enters Duty Mode after it has exited all other modes;
- When the fire control panel enters SetUp Mode or Remote Control Mode it exits all other conditions.



7. Duty Mode

7.1. Description

The fire control panel is in Duty Mode, when it is not in any other of the rest 8 possible conditions

7.2. Indication

7.2.1. LED and sound indication

In Duty Mode are active the green LED indicator  (Power supply) and the yellow indicator  (Day Mode – it illuminates only when the fire control panel is in Day Mode). The local sounder is switched off.

7.2.2. Text message

Message DUTY and the current time are displayed on the LCD display:

Duty	17:05:34
Thursday	16-10-2003

7.3. Using the keypad

The only accessible button in Duty Mode is  (Menu). Press it and the fire control panel enters Information and Control Mode.

8. Fire condition

8.1. Description

The fire control panel enters Fire Condition after a fire detector has been activated in one of the fire alarm lines. In Day Mode the condition has two phases – Fire condition stage I and Fire condition

stage II. The time period for Fire condition stage I is limited and is user programmable, separately for each line (up to 255 seconds). The period can be prolonged with the Inspection time (see section 8.3.1). When Fire condition stage I in one line expires, the fire control panel enters Fire condition stage II in the same line.

The fire control panel enters Fire condition stage I upon activation of an automatic fire detector when the current value in the line is between the limits for Fire condition stage I and Fire condition stage II. The fire control panel enters Fire condition stage II upon activation of a manual call point when the current in the line is between the limits for Fire condition stage I and Short circuit. All threshold values are user defined, separately for each line (see sections 14 and 14.3.1). Night Mode phase Fire condition stage I is ignored. The fire control panel enters Fire condition, phase Fire condition stage II:

- upon activation of an automatic fire detector when the current value in the line is between the limits for Fire condition stage I and Fire condition stage II, and
- upon activation of a manual call point when the current in the line is between the limits for Fire condition stage I and Short circuit.

The fire control panel can be in Fire Condition in one or more lines. When the fire control panel is in Day Mode, it can register Fire condition stage I in part of the lines, and Fire condition stage II in the rest of the lines.

To exit this condition press button  at Access level 2 (see section. 8.3.4) for each fire alarm line in fire condition. If a System fault occurs the operation of Fire condition will suffer changes (see section 10.1).

8.2. Indication

8.2.1. LED and sound indication

In this condition the common light indicator  (Fire condition stage I) and/or  (Fire condition stage II) flash in red.

If the outputs for fire condition are suppressed by button  (Outputs), the LED indicator on the button will illuminate in red.

If Inspection time has been entered, the indicator  illuminates in continuous green light (Inspection).

The local sounder produces continuous signal. If the sound indication has been suppressed by button  (Alarm), the LED indicator on the button illuminates in continuous red light.

8.2.2. Text message

Information for all lines in Fire condition appears on the display:

```

N1 Fire 1 LnNN   SSSs
Message 1
N2 Fire 2 LnNN
Message 2
```

The display is divided into two text fields each containing two lines. Information on the first line in Fire condition is visualized in the first (top) field; information on the last line in Fire condition – in the second (bottom) field.

The first line of each field displays information on the type of the Fire condition:

- N1 is the consecutive number of the Fire condition, indicated in the first field;
- N2 is the consecutive number of the Fire condition, indicated in the second field (in our case, this is the last fire condition, so N2 is the total number of fires);
- Fire1 / Fire2 is the phase of the Fire condition registered for this line;
- NN is the line number
- SSS is the remaining time in seconds, before the fire control panel proceeds to Fire condition stage II (it is indicated only in Fire condition stage I).

The second line of each field displays a text message for the corresponding fire alarm line.

If there are more than two lines in Fire condition, the rest of the text messages are suppressed. They can be displayed in the first field by the means of the keypad (see section 8.3.5).

8.3. Using the keypad

8.3.1. Button (Inspection)

When you press the Inspection button, the time period, already programmed by the user, will be added to the remaining time for all lines in Fire condition stage I before they proceed to Fire condition stage II.

The button is active when a fire alarm line enters Fire condition stage I.

8.3.2. Button (Alarm)

Press it to:

- Switch off the local sounder if it responded to Fire condition/Pre-fire condition or Fault condition;
- Activate the local sounder if the control panel I in Fire condition, Pre-fire condition or Fault condition and the sounder has been suppressed by previous pressing of the same button.

The LED indicator on the button illuminates if the sounder has been switched off after response to Fire condition, Pre-fire condition or Fault condition.

The button does not affect and is not cancelled by the following events:

- When a new line enters Fire condition or proceeds from Fire condition stage I to Fire condition stage II, the local sounder will be activated due to Fire condition/Pre-Fire condition;
- When a new line enters Pre-Fire condition the local sounder will be activated for Fire condition/Pre-Fire condition only;
- A new Fault condition will trigger the local sounder for Fault condition only.

The LED indicator of the button stays illuminated, if the signalizations and/or the outputs remain off.

The button is active at Access levels 1 and 2.

8.3.3. Button (Outputs)

The button operation depends on the current access level and on the status of the fire control panel.

At Access level 1 (the key on the front panel is in position ) and some fire alarm lines are in phase Fire condition stage I, the button will trigger forced proceeding to phase Fire condition stage II in effect for these particular lines.

At Access level 2 (the key on the front panel is in position ) and some fire alarm lines are in phase Fire condition stage I, the button has the following operations:

- If no activated outputs for fire condition are available – the button will trigger forced proceeding to Fire condition stage II effective to these lines;
- If activated outputs for fire condition are available – the button will suppress the outputs.

At Access level 2 (the key on the front panel is in position ) and no fire alarm lines are in Fire condition stage I (i.e. the fire control panel is in phase Fire condition stage II) the button has the following operations:

- If activated outputs for fire condition are available - the button will suppress the outputs;
- If no activated outputs for fire condition are available – the button will activate the suppressed outputs, if any.



The LED indicator on the button illuminates if some outputs for fire condition are suppressed.



8.3.4. Button (Reset of line)



It forces the fire control panel to exit Fire condition in the fire alarm line, indicated in the first line of the LCD display, and resets the line (cuts off the power supply for 3 seconds).

The button is active at Access level 2 (the key on the front panel is in position )

8.3.5. Buttons (Down) and (Up)

If there are suppressed messages for fire condition they can be displayed in the first field of the LCD display using buttons  and  situated on the front panel.

Press button  to display the next text message for fire condition. When the last text message is reached, press button  to display the first message.

Press button  to display the previous text message for fire condition. When the first message is reached press button  to display the last message.

If a suppressed message is displayed, 20s after the button is pressed for the last time the first message for fire condition will restore automatically.

8.3.6. Button (Menu)

Press the button to enter Information and Control Mode.

8.3.7. Button (Cancel)

When Fire condition is combined with Information and Control Mode, press the button continuously to cancel the Information and Control Mode; the first field will then display information on the first fire alarm line in Fire condition.

9. Pre-Fire condition

9.1. Description

Pre-Fire condition ensures the correct operation of the Function “Logical AND” for two lines (see section 6.3).

9.2. Indication

9.2.1. LED and sound indication

The common indicator  (Fire condition stage I) illuminates in continuous red light to indicate the condition.

The local sounder emits discontinuous asymmetrical signal - 4 sound impulses for 1 s, then pause for 1s. If the sound indication has been suppressed by button  (Alarm), the LED indicator on the button illuminates in steady red light.

9.2.2. Text message

The message DUTY and the real time are displayed on the LCD display.

Duty	17:05:34
Thursday	16-10-2003

This message can be suppressed from the screen for Fire Condition. To display the suppressed messages enter Information and Control Mode (see section 13.6).

9.3. Using the keypad

9.3.1. Button (Alarm)

Press the button to:

- Switch off the local sounder if it responded to Fire condition/Pre-fire condition or Fault condition;
- To activate the local sounder of the fire control panel is in Fire condition/Pre-fire condition or Fault condition and the local sounder is suppressed by a previous push on the same button;
- The LED indicator on the button illuminates if the local sounder is suppressed after response to Fire condition/Pre-fire condition or Fault condition;

The button does not affect nor is its action cancelled by the following events:

- When Fire Condition is registered in a new line, or transition from Fire condition stage I to Fire condition stage II the button shall activate the local sounder for Fire/Pre-Fire condition;
- When Pre-Fire Condition is registered in a new line, the button will activate the local sounder for Fire/Pre-Fire condition;
- A new Fault condition shall activate the local sounder for Fault condition only.

The button is active at Access levels 1 and 2.

9.3.2. Button  (Menu)

Press the button to enter Information and Control Mode.





10. Fault condition

10.1. Description

The fire control panel enters Fault Condition when any of the events below has been registered:

- Fatal System fault, including New configuration;
- Battery Low – backup batteries discharged due to interruption in mains supply;
- Fault in the program of Linear processor 2;
- Fault in the data of Linear processor 2;
- Fault in the program of Linear processor 3;
- Fault in the data of Linear processor 3;
- Failure in the real time clock;
- Failure in the external memory;
- Wrong record in the external memory;
- Fault in a line – removed fire detector, short circuit or break;
- Fault in a controllable output – short circuit or break;
- Fault in main supply;
- Fault in backup batteries power supply;
- Short circuit in grounded wire;
- Fault in the positive supply to the lines;
- Fault in the negative supply to the lines;
- Fault in power supply to external devices

Where a *Fatal System fault* occurs (except for New configuration) the main processor is not able to continue operation. In this case:

- only the linear processors that service the fire alarm lines and the controllable outputs are in operation;
- phase Fire condition stage I is ignored and if an automatic fire detector is activated, the control panel enters Fire condition, phase Fire condition stage II;
- in Fire condition will be activated Relay output 1 and Controllable output 1 (for lines 1 – 16) or Controllable output 2 (for lines 17 – 32); the rest of the relay outputs for fire condition do not function;
- if the defected component is the LCD display, the information on it is not correct;
- from the LED indication only  (Fault condition),  (System fault),  (Fire condition stage II) and  (Power supply) are functioning;
- the buttons do not work.

You can exit the fault condition if you disconnect the control panel from the mains supply and send it for repairs.

New configuration is a fatal system fault – the fire control panel does not service lines, outputs or other peripherals. To exit the condition you shall enter SetUp Mode. Such fault condition occurs usually after modification of the physical configuration of the fire control panel – addition, removal or replacement of additional module.

Battery Low is a fatal non-system fault – the control panel does not service fire alarm lines or outputs. The unit enters a specific condition:

- Discontinuous sound signal is released - 1s sound, 3s pause, for at least an hour;

- Only the green LED indicator is illuminated  (Power supply);
- The backlight of the display is extinguished;
- Only the power supplies are being controlled.

The fire control panel exits the status automatically 8 s after the mains supply is restored.

All other faults are not fatal and switch off some of the periphery devices only. The fire control panel exits such conditions automatically 8 s after the breakdown is eliminated.

Upon *Short circuit in ground wire* occur the following faults:

- Fault Condition in a line (fire detector removed) – where the short circuit is in fire alarm line's component;
- Fault Condition in controllable output (interruption) – where the short circuit is in a component of a controllable output.





In Fault Condition the relevant messages are shown on the display. Additional information is acquired from the LED indication.

10.2. Indication

10.2.1. LED and sound indication

In *Low Battery* no LED indicator is illuminated. The local sounder produces discontinuous sound (1 s sound, 3 s pause). The backlight of the LCD is off.

In all other fault conditions the indicator  (Fault condition) flashes in yellow. Depending on the type of the fault condition the following indicators are illuminated:

- System fault – indicator  (System fault) is illuminated in flashing yellow light;
- New configuration - indicator  (System fault) is illuminated in flashing yellow light
- Fault in controllable output - indicator  (Out of order / Disabled controllable output) flashes in yellow light.
- Fault in mains supply - indicator  (Fault in mains supply) flashes in yellow light;
- Fault in backup batteries - indicator  (Backup battery fault) flashes in yellow light.

The local sounder is activated and produces discontinuous signal. If the sound indication has been suppressed by button  (Alarm), the LED indicator on the button illuminates in steady red light.

10.2.2. Text messages

The messages for fault condition have a priority order, as ranged in section 10.1. The screens for fatal errors suppress all other messages. If more than one non-fatal error has been detected, they are indicated according priority; the message of highest priority suppresses all other messages.

10.2.2.1. The following information screens appear upon detection of fatal errors (except for New configuration):

- * System fault (the text message in the third line contains information for the maintenance and repairs staff).
The screen suppresses all other screens and can not be suppressed.
- * Battery low
The screen suppresses all other text messages except for System fault message, and can not be suppressed.

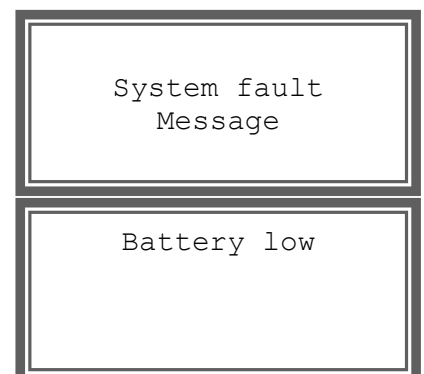

10.2.2.2. Upon detection of New configuration or non-fatal errors, and the fire control panel is not in Fire condition, appear the following information screens:

- * New configuration:
(The field "EEE" contains the number of the faults)

```
Duty      17:05:34
Flt:EEE New config
```
- * Fault in the program of Linear processor 2:
(The field "EEE" contains the number of the faults)

```
Duty      17:05:34
Flt:EEE Fault Code 2
```
- * Fault in the program of Linear processor 3:
(The field "EEE" contains the number of the faults)

```
Duty      17:05:34
Flt:EEE Fault Code 3
```
- * Fault in the data in Linear processor 2:
(The field "EEE" contains the number of the faults)

```
Duty      17:05:34
Flt:EEE Fault Data 2
```
- * Fault in the data in Linear processor 3:
(The field "EEE" contains the number of the faults)

```
Duty      17:05:34
Flt:EEE Fault Data 3
```
- * Fault in real time clock:
(The field "EEE" contains the number of the faults)

```
Duty      17:05:34
Flt:EEE Fault Timer
```
- * Fault in external memory:
(The field "EEE" contains the number of the faults)

```
Duty      17:05:34
Flt:EEE Fault EEPROM
```
- * Writing record in the external memory:
(The field "EEE" contains the number of the faults)

```
Duty      17:05:34
Flt:EEE Flt Wr EPROM
```
- * Fault in a line:
(The field "EEE" contains the number of the faults;
"NN" contains the number of the line in fault condition;
"Status" contains the state of the line, i.e. the type of the fault)

```
Duty      17:05:34
Flt:EEE LnNN Status
```

- * Fault in a controllable output:
(The field “EEE” contains the number of the faults;
“NN” contains the number of the controllable output in
fault condition;
“Status” contains the state of the controllable output, i.e.
the type of the fault)
- * Fault in mains supply:
(The field “EEE” contains the number of the faults)
The backlight of the LCD display is extinguished and will
only illuminate if a button is pressed. 20s after the last
time the button is pressed is extinguishes again.
- * Fault in backup battery supply:
(The field “EEE” contains the number of the faults)
- * Fault in Auxiliary supply of external devices in Basic
Module – a fuse is activated:
(The field “EEE” contains the number of the faults)
- * Short circuit in grounded wire:
(The field “EEE” contains the number of the faults)
- * Fault in the positive supply of the lines in Basic module
(The field “EEE” contains the number of the faults)
- * Fault in the positive supply of the lines in Additional
module:
(The field “EEE” contains the number of the faults)
- * Fault in the negative supply of the lines in Basic module:
(The field “EEE” contains the number of the faults)
- * Fault in the negative supply of the lines in Additional
module:
(The field “EEE” contains the number of the faults)

```
Duty      17:05:34
Flt:EEE cONN Status
```

```
Duty      17:05:34
Flt:EEE Flt Mn Power
```

```
Duty      17:05:34
Flt:EEE Flt Battery
```

```
Duty      17:05:34
Flt:EEE Flt AuxPower
```

```
Duty      17:05:34
Flt:EEE Flt Earth
```

```
Duty      17:05:34
Пвр:EEE Flt LnPower1
```

```
Duty      17:05:34
Flt:EEE Flt LnPower2
```

```
Duty      17:05:34
Flt:EEE Flt NgPower1
```

```
Duty      17:05:34
Flt:EEE Flt NgPower2
```

Fault in the supply to external devices in Basic module:
(The field "EEE" contains the number of the faults)

```
Duty      17:05:34
Flt:EEE Flt Out Pwr1
```

* Fault in the supply to external devices in Additional module:
(The field "EEE" contains the number of the faults)

```
Duty      17:05:34
Flt:EEE Flt Out Pwr2
```

When the fire control panel is in Fire condition, the messages for fault are suppressed.
To display the suppressed messages enter Information and Control Mode (see section 13.2).

10.3. Using the keypad

In fatal fault condition (except for New configuration) none of the buttons is active.

For the rest fault conditions 2 active buttons are supported. When the control panel operates in combination with other conditions, their buttons are active too.

10.3.1. Button (Alarm)

Press the button to:

- Switch off the local sounder if it responded for Fire condition/Pre-Fire condition or Fault condition;
- Activate the local sounder if the Fire control panel is in Fire condition/Pre-Fire condition or Fault condition and the local sounder is previously suppressed by the same button.

The LED indicator on the button is illuminated if the local sounder is switched off after it responded for Fire condition/Pre-Fire condition or Fault condition.

The button does not affect nor is its action cancelled by the following events:

- When Fire Condition is registered in a new line, or transition from Fire condition stage I to Fire condition stage II the button shall activate the local sounder for Fire/Pre-Fire condition
- When Pre-Fire Condition is registered in a new line, the button will activate the local sounder for Fire/Pre-Fire condition;
- When a new Fault condition is registered, the button shall activate the local sounder for Fault condition only.

The button's LED indicator remains illuminated if the signalization and/or outputs remain off.

The button is active at Access levels 1 and 2.

10.3.2. Button (Menu)

Press the button to enter Information and Control Mode.

11. Disabled Component Mode

11.1. Description



The fire control panel enters Disabled Component Mode after a component has been manually disabled – a fire alarm line or a controllable output. The condition is controlled via the screens of Information and Control Mode (see sections 13.7.6 and 13.7.7). The disabled line is switched off (the power supply is cut off) and is not monitored for activated fire detector and faults. The disabled controllable output is switched off (the executive device can not operate) and is not monitored for faults.

In case of disabled fire alarm lines a relevant message is shown on the display.

Additional information is acquired from the LED indicators.

11.2. Indication

11.2.1. LED and sound indication

In such condition the common indicator  (Disabled component) illuminates in steady yellow light. If there are disabled controllable outputs the indicator  (Out of order/Disabled controllable output) illuminates in steady yellow light. The indication can be suppressed by indication for a fault in controllable output; the indicator will then flash in yellow (see 10.2.1).

No sound indication is supported for Disabled Component Mode.

11.2.2. Text messages

If there are disabled lines the following information screen is displayed

(The field "DD" contains the number of disabled lines and controllable outputs)

```
Duty      17:05:34
Thursday 16-10-2003
Dis:DD LnNN Disable
```

If there are disabled controllable outputs the following information screen is displayed:

(The field "DD" contains the number of disabled lines and controllable outputs.)

```
Duty      17:05:34
Thursday 16-10-2003
Dis:DD cONN Disable
```

The messages can be suppressed from the screens for Fire Condition. To display the suppressed messages enter Information and Control Mode (see section 13.3).

11.3. Using the keypad

Disabled Component Mode supports 1 active button. When the control panel operates in combination with other conditions, their buttons are active too.

Press button  (Menu) to enter Information and Control Mode.

12. Test Mode

12.1. Description

The fire control panel enters Test Mode after a fire alarm line has been manually set to operate in test condition. The mode can be controlled via the screens for Information and Control Mode (see section 13.7.5).

When a fire alarm line is in test condition, the following operational changes are in effect:

- Upon registration of Fire condition stage I or Fire condition stage II in this line the sound indications, light indications, associated controllable and relay outputs do not operate – i.e. the fire control panel does not enter Fire Condition;
- Upon registration of Fault in a line the sound indicators, light indicators and the relay output for fault condition do not operate – i.e. the fire control panel does not enter Fault Condition;
- The events registered for the line are not saved in the energy independent memory;
- The line is being automatically reset (the power supply is interrupted for 3 s) every 64s.

12.2. Indication

12.2.1. LED and sound indication

The common indicator  (Test) illuminates in steady yellow light. Sound signaling for the condition is not supported.

12.2.2. Text messages

If fire alarm lines in test are available appears the following information screen:

(The field "TT" contains the number of lines in test)

```
Duty      17:05:34
Thursday 16-10-2003

Tst:TT LnNN Test
```

The message can be suppressed by the screens for Fire condition. To display the suppressed messages enter Information and Control Mode (see section 13.4).

12.3. Using the keypad





Test Mode supports 1 active button. When the control panel operates in combination with other conditions, their buttons are active too.

Press button  (Menu) to enter Information and Control Mode.

13. Information and Control Mode



13.1. Description

Information and Control Mode enables the user to display information for the fire control panel and to enter data for control.

Press button  to enter the mode through the screens of Duty Mode, Fire condition, Pre-Fire condition, Fault condition (fatal errors excluded, except for New configuration), Test mode and Disabled Component; their text messages are suppressed. When the control panel operates in combination of Information and Control Mode and Fire/Pre-Fire condition, button  (Alarm) is active too. When the control panel operates in combination of Information and Control Mode and Fire condition, buttons  (Alarm),  (Outputs) and  (Inspection) are active too.

No specific LED or sound indication is provided for the condition.

The screens displayed on the LCD are organized in a tree structure of subordinate menus. (Appendix 2). Transition to a menu of successive (lower) level is performed by pressing the button





; transition to a menu of previous (higher) level is performed by pressing the button .

Moving between menus of one and the same level is performed by pressing the buttons  and



The screens containing particular information (information screens) or permitting parameters change and command execution (command screens) are on the last (lowest) level.

On information screens the button  is not active, the rest three buttons retain their functions. When a screen for change in parameters or a command screen is activated, a cursor appears. In this case the buttons have the following operation:

- Press button  to save a change in a parameter or to execute a selected command; afterwards the screen is deactivated and the cursor disappears (differences in button's effect in some cases are explicitly stated);
- Press button  to deactivate the screen without saving any changes or without execution of the relevant command; the cursor disappears;
- Button  is active only on screens for parameter change. Press the button when:
 - ◆ The cursor selects a digit – then the cursor will move with one position to the right. When the last position is reached, the cursor moves back to the first position;
 - ◆ The cursor is to the right of the parameter – then the parameter will decrease its value to the next lower possible value. When the lowest value is reached, the cursor moves back to the highest possible value of the parameter;
- Button  operates only on screens for parameter change. Press it to increase the selected digit with one step or to increase the parameter to the next possible rate (when the cursor is to the right of the parameter). In both cases, when the maximum possible rate is reached, a transition to the lowest possible rate is made

Information and Control Mode displays information in the first two lines, used by the Fire condition to indicate the first fire alarm line in Fire condition

When you enter the Information and Control Mode, a transition to the first menu is performed. The menu contains the following subordinate menus:

- Faults
- Disabled components
- Lines in test
- Status
- Pre-Fire condition
- System functions

13.2. Menu *Faults*

To select the menu use the screen:

```

└─01 Faults
  02 Disables
  
```

The menu contains information screens with the suppressed messages for fault conditions.

When no fault conditions are present appears the next information screen:

```

Faults
No faults
  
```

When fault conditions are present appear the next information screens:

(The field "NN" contains the consecutive number of the fault;
"EE" contains the total number of faults;

The field "Text for fault" contains information for the fault condition)

```

Fault      NN  of EE
Message for fault
  
```

13.3. Menu *Disabled components*

Select the menu from the screen:

```

└─02 Disables
  03 Lines in Test
  
```

The menu contains information screens with suppressed messages for disabled components.

When no disabled components are present appears the next information screen:

```

Disables
No disables
  
```

When disabled components are available, the following information screen appears:

(The field "NN" contains the consecutive number of the indicated disabling;

"EE" contains the total number of disables;

The field "Text for disables" contains information for the disabling.)

```

Disable   NN  of EE
Message for disables
  
```

13.4. Menu *Lines in test*

Select the menu from the screen:

```

▶03 Lines in Test
 04 Status
  
```

The menu contains information screens with suppressed messages for lines in test.

Where no lines in test are available appears the following information screen:

```

Lines in Test
No Lines in Test
  
```

Where some lines in test are available the following information screen appears:

(The field "NN" contains the consecutive number of the message for a line in test;

"EE" contains the total number of lines in test;

"XX" contains the number of a specific line in test)

```

Test      NN   of EE
Line XX
  
```

13.5. Menu *Status*

Select the menu from the screen:

```

▶04 Status
 05 Pre-fire
  
```

The menu contains information screens with the status of lines and controllable outputs.

Information screen for the status of the line appears:

(The field "NN" contains the number of the selected line

"Status" contains information on its status)

```

          Status
LnNN Status
  
```

Information screen for the status of the controllable output appears:

(The field "NN" contains the number of the selected controllable output;

"Status" contains information on its status)

```

          Status
cONN Status
  
```

The following statuses are possible:

- Normal – for a line/controllable output in normal state;
- Fire1 – for a line in phase Fire condition stage I (only when no fault condition is registered);
- Fire2 - for a line in phase Fire condition stage II (only when no fault condition is registered);
- PreFire - for a line set in LOGICAL AND dependency, an automatic fire detector is activated in this line and a second fire alarm line is expected to enter Fire condition (only when no fault condition is registered);
- Removed FD – for a line with removed fire detector;
- Break – for a break in a line/ controllable output;
- Short circuit – for short circuited line/controllable output ;
- None – for a line/controllable output not present in the configuration (the status appears also if the control microprocessor for a line/controllable output fails).

13.6. Menu *Pre-Fire condition*

Select the menu from the screen

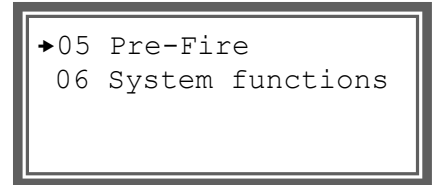

The menu contains information screens with suppressed messages for Pre-fire condition.

If no lines in Pre-fire condition are available, the following information screen appears:

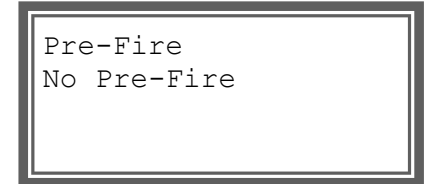

If some lines in Pre-fire condition are available, the following information screen appears:

(The field "NN" contains the number of the indicated message for a line in Pre-Fire condition;
 "EE" contains the total number of lines in Pre-Fire condition;
 "XX" contains the number of the line in Pre-Fire condition)

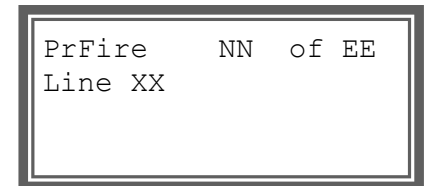

13.7. Menu *System functions*

Select the menu from the screen

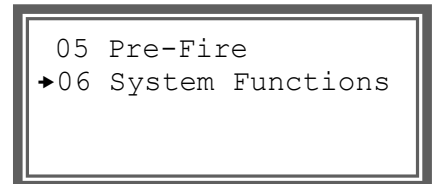

The menu contains the following subordinated menus and operations (Appendix 2b):

- LED and sound indicators check up;
- Current in fire alarm lines;
- Mode;
- Setting the real time clock;
- Fire alarm lines test;
- Disable fire alarm lines;
- Disable controllable outputs;
- Parameter review;
- Adjustment
- Archive review.

The subordinate menu can be entered at Access level 2, i.e. when the key on the front panel is

turned to position .

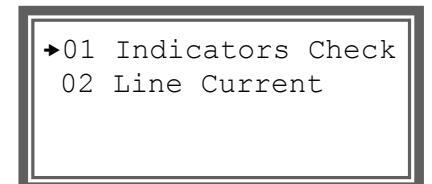

13.7.1. Function *LED and sound indicators check up*

Screen for function activation:

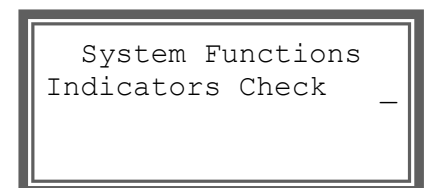

Press button  to activate the function and the following screen appears:



When the button  is pressed, all LED indicators illuminate and the sound indicator releases continuous sound signal as long as the button is being pressed. To deactivate the function press button ; the cursor disappears.

13.7.2. Menu *Current in fire alarm lines*

Select the menu from the screen:

```

▶02 Line Current
03 Mode

```

Information screens for current in the lines appear:
(The field “NN” contains the number of the selected line;
“CCC” contains the current value in mA.)

```

System Functions
Line CurrentNN CCCmA

```

13.7.3. Menu *Mode*

Select the menu from the screen:

```

▶03 Mode
04 Clock

```

When the function is active a cursor appears over the last position in the line:
(The field “MMM” contains the current mode of operation: Day or Night Mode.)

```

System Functions
Mode           MMM _

```

13.7.4. Menu *Setting the clock*

Select the menu from the screen

```

▶04 Clock
05 Test Line

```

The menu contains the following functions:

- Setting the date
- Setting a day of the week
- Setting the time
- Calibration

13.7.4.1. Function *Setting the date*

Activate the function from the screen

(The field “DD” contains the current date
“MM” contains the current month
“YY” contains the current year)



```

Clock
01 Date   DD-MM-YYYY

```

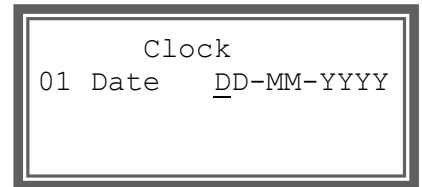
When the function is active a cursor appears over the first left digit of the date "DD":



To set the desired date use buttons  and . It is not possible to set a value higher than 31 in "DD" and higher than 12 in "MM". If you try to exceed the values the field will reset and the cursor will move back over the first digit of the field.

After the desired date is set, press button  and if the values have been properly set, (the values of "DD" and "MM" are within the limits) the function is deactivated. If a wrong value is entered, the screen remains unchanged and the cursor is positioned over the first digit of the date "DD".

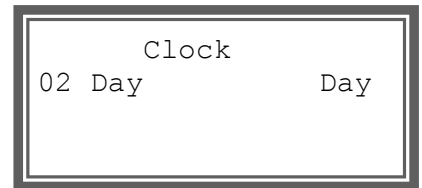

13.7.4.2. Function *Setting a day of the week*
Activate the function from the screen

(The field "Day" contains the current day of the week.)

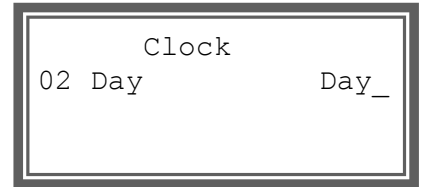

When the function is active a cursor appears in the end of the line:







Set the desired day of the week by using buttons  and . After the desired day of the week is set, press button  and the function is deactivated.

13.7.4.3. Function *Setting the time*
Activate the function from the screen

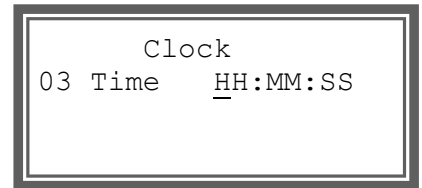
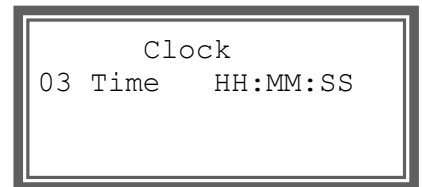
(The field "HH" contains the current hour;
"MM" contains the minutes;
"SS" contains the seconds)

When the function is active a cursor appears over the first left digit of the hour "HH":



Set the desired time by using the buttons  and . It is not possible to set a value higher than 23 for the field "HH" and higher than 59 for the fields "MM" and "SS". If you try to exceed the limits the fields will reset and the cursor moves back to the first left digit of the field. After the desired time is set, press button  and the function is deactivated.

13.7.4.4. Function *Calibration*

Activate the function from the screen

(The field "s" contains the symbol + or - ;
"CC" contains the calibration index)

```

      Clock
04 Calibration  sCC
  
```

When the function is active a cursor appears over the last position in the line:

```

      Clock
04 Calibration  sCC_
  
```

Each positive device accelerates the clock at the rate of 10,7s per month; each negative device delays the clock at the rate of 5,35s per month. The maximum rate is e +5,5min per month or -2,75min per month.

13.7.5. Menu *Fire alarm lines test*

Activate the menu from the screen

```

▶05 Test Line
06 Disable Line
  
```

The menu contains 8, 16, 24 or 32 functions depending on the fire alarm lines available in the configuration:

(when XX is "No" the line is not in test; when XX is "Yes: the line is in test)

```

      Test Line
Line  NN          XX
  
```



To switch between the functions use buttons  and ,

to activate e function use button .

When the function for a specific line is activated a cursor appears over the last position of the line:

```

      Test Line
Line  NN          XX_
  
```

Using buttons  or  you can alternatively change the value of XX from "No" to "Yes"

and vice versa. The changes (set line in test/ exit test) will be saved when you press button .

the function though is not deactivated. It can be deactivated by button .

Button  triggers all outputs (controllable and relay outputs) which are usually activated when the indicated fire alarm line in Test condition enters Fire condition stage I or II. The outputs are active as long as the button is being pressed. The button is in effect is the value for XX is "Yes".



13.7.6. Menu *Disable fire alarm lines*

Activate the menu from the screen

```



▶06 Disable Line
07 Disable cOut
  
```

The menu contains 8, 16, 24 or 32 functions depending on the fire alarm lines available in the configuration (when XX is “No” the line is enabled, when XX is “Yes” the line is disabled.)

To switch between the functions use buttons  and , to activate e function use button .

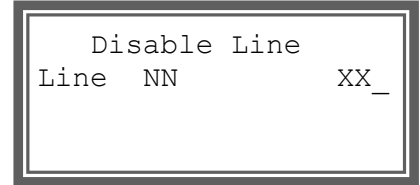
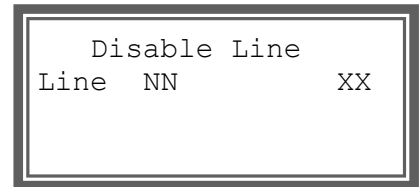

When the function for a specific line is activated a cursor appears over the last position of the line:



Using buttons  or  you can alternatively change the value of XX from “No” to “Yes” and vice versa. The changes (enable/disable line) will be saved when you press button , the function will be deactivated.



13.7.7. Menu *Disable controllable outputs*
 Activate the menu from the screen

The menu contains 1 or 2 functions depending on the controllable outputs available in the configuration:
 (when XX is “No” the controllable output is enabled, when XX is “Yes”, the controllable output is disabled)

To switch between the functions use buttons  and , to activate e function use button .

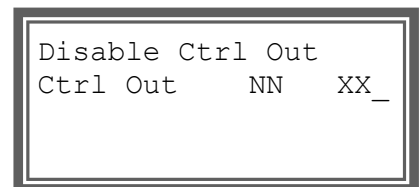
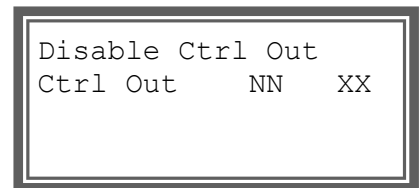
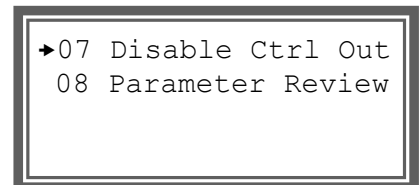
When the function for a particular controllable output is activated a cursor appears over the last position of the line:



Using buttons  or  you can alternatively change the value of XX from “No” to “Yes” and vice versa. The changes (enable/disable controllable output) will be saved when you press button , the function will be deactivated.

13.7.8. Menu *Parameter review*
 Select the menu from the screen:

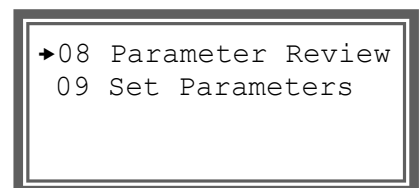

The menu contains the following subordinate menus (Appendix 2c):
 01 Configuration
 02 Line parameters
 03 Fire control panel parameters

13.7.8.1. Menu *Configuration*

Select the menu from the screen:

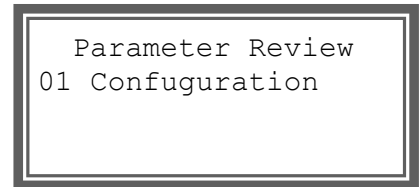

The menu contains the following information screens:

01 Lines:

(The field "LL" contains the number of lines available in the configuration)

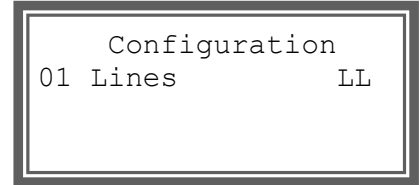

02 Controllable outputs:

(The field "KK" contains the number of controllable outputs available in the configuration.)

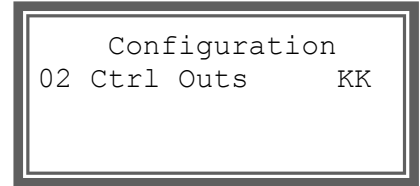

03 Relay outputs

(The field "RR" contains the number of relay outputs available in the configuration)



13.7.8.2. Menu *Line parameters*

Select the menu from the screen:

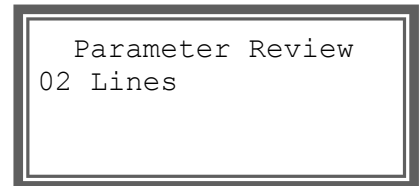

The menu contains 8, 16, 24 or 32 subordinated menus, one for each line. When you enter the menu, the subordinate menu for Line 1 is displayed and the desired line can be selected.

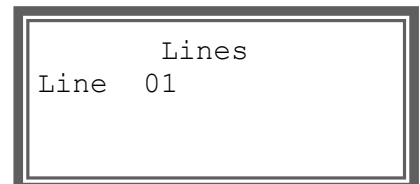

Each of the subordinate menus contains information screens and submenus for the following line parameters:

01 Number of checks:

The field "NN" contains the number of the line;
"X" contains the number of the checks - 1 to 3.

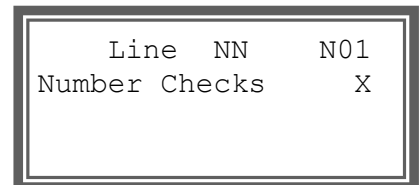

02 Check for removed fire detectors:

The field "NN" contains the number of the line;
When "XX" contains "No", the check is not performed; when XX contains "Yes" the check is performed

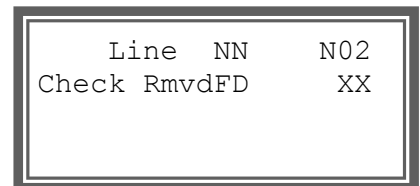

03 Period for transition from Fire condition stage I to Fire condition stage II:

The field "NN" contains the number of the line;
"SSS" contains the period in seconds - 0 to 255s.

Line NN	N03
Time F1-F2	SSSs

04 Current threshold above which Fire condition stage I is detected in a line:

The field "NN" contains the number of the line;
"CCC" contains the current in mA - 1 to 80mA.

Line NN	N04
Current Fire1	CCmA

05 Current threshold above which Fire condition stage II is detected in a line:

The field "NN" contains the number of the line;
"CCC" contains the current in mA - 1 to 80mA.

Line NN	N05
Current Fire2	CCmA

06 Current threshold above which Short circuit is detected in a line:

The field "NN" contains the number of the line;
"CCC" contains the current in mA - 1 to 80mA.

Line NN	N06
Current Short	CCmA

07 Current threshold below which Interruption in a line is detected:

The field "NN" contains the number of the line;
"CCC" contains the current in mA - 1 to 80mA.

Line NN	N07
Current Interr	CCmA

08 Logical AND dependency of a line:

The field "NN" contains the number of the line;
"XX" may adopt value 00 (the line is not in Logical AND dependency by another line) or values from 01 to 32 (number of the line with Logical AND dependency by the current line).

Line NN	N08
Logic &	XX

09 Menu Controllable outputs in Fire condition stage II in the line:

The field "NN" contains the number of the line.

Line NN	N09
Ctrl Outs F2	

The menu contains 1 or 2 information screens depending on the available controllable outputs:

The field "KK" contains the number of the controllable output;
"XX" can contain "No" (the controllable output will not be activated in Fire condition stage II) or "Yes" (the controllable output will be activated).

Line NN	N09
F2 Ctrl Out KK	XX

10 Menu Relay outputs in Fire condition stage I in the line

The field "NN" contains the number of the line.

Line NN	N10
Relays F1	

The menu contains 2, 10 or 18 parameters depending on the relay outputs available in the configuration:
 The field "RR" contains the number of the relay output;
 "XX" can contain "No" (the relay output will not be activated in Fire condition stage I) or "Yes" (the relay output will be activated).

```

Line NN N10
F1 Relay RR XX
  
```

- 11 Menu Relay outputs in Fire condition stage II in the line
 The field "NN" contains the number of the line.

```

Line NN N11
Relays F2
  
```

The menu contains 2, 10 or 18 parameters depending on the relay outputs available in the configuration:
 The field "RR" contains the number of the relay output;
 "XX" can contain "No" (the relay output will not be activated in Fire condition stage II) or "Yes" (the relay output will be activated).

```

Line NN N11
F2 Relay RR XX
  
```

- 12 Text message for the line:
 The field "NN" contains the number of the line.
 "TTTTTTTTTTTTTTTTTTTT" contains the text message.

```

Line NN N12 (Text)
TTTTTTTTTTTTTTTTTTTT
  
```

13.7.8.3. Menu *Fire control panel parameters*

Select the menu from the screen:

```

Parameter Review
03 Fire Panel
  
```

The menu contains the following information screens and a menu:

- 01 Inspection time:
 (The field "SSS" contains the time in seconds - from 0 to 255s; this period is added to the period, necessary for the transition from Fire condition stage I to Fire condition stage II in a line when button  is pressed);

```

Fire Panel N01
Inspection time SSSs
  
```

- 02 Interface number:
 (The field "NNNN" contains the address for data exchange via interface - from 0000 to 9999);

```

Fire Panel N02
Interface Nmb NNNN
  
```

- 03 Baud rate:
 (The field "BBBB" is the baud rate of exchange via interface (bits in second) - 1200, 2400, 4800 or 9600 bd);

```

Fire Panel N03
Baud Rate BBBBbd
  
```

- 04 Modem supported:
 (When the field "XX" contains "No", a modem is not supported via interface RS232, when it contains "Yes" a modem is supported)

```

Fire Panel N04
Modem XX
  
```

05 Menu Phone numbers:

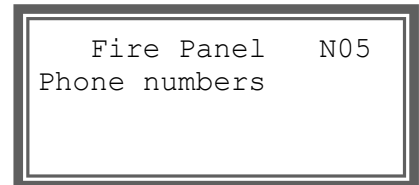

The menu contains 4 information screens, one for each phone number:
 (The field “N” contains the consecutive number of the phone number;
 “III” contains the type of dialing – pulse or tone
 “TTTTTTTTTTTTTTTTTTTT” contains the phone number)

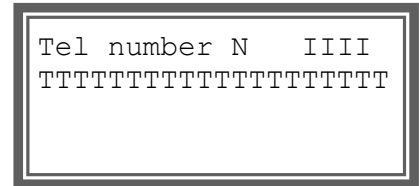

13.7.9. Menu *Set Parameters*

Select the menu from the screen:



This is the menu Set Parameters (see section 14).

13.7.10. Menu *Archive review*

Select the menu from the screen:



The menu allows the user to display information on all events saved in the archive of the energy-independent memory.

First appears the information screen for the total number of fires registered after the control panel started initial operation:
 (The field “NNNN” contains the total number of fires.)

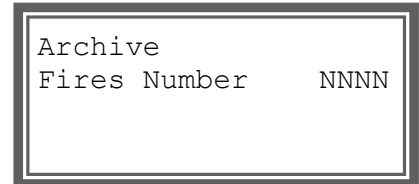

The next information screens display particular information for each event registered by the control panel:

The field “NNN” contains the number of the record in the archive;

The field “XXX” contains the total number of records in the archive;

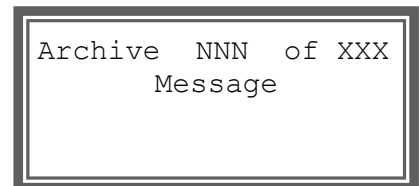

The field “Text message” may contain the exact text of the record and may be:

- LnNN Fire1 – line number NN enters Fire condition stage I;
- LnNN Fire2 – line number NN enters Fire condition stage II;
- LnNN Rst from Fire – line number NN restored from Fire condition;
- LnNN RmvdFD – line number NN enters Fault condition: Removed fire detector;
- LnNN Interrupt – line number NN enters Fault condition : Break in a line;
- LnNN Short – line number NN enters Fault condition: Short circuit in a line;
- LnNN Normal – line number NN restored from Fault condition;
- LnNN Disable – line number NN is disabled;
- LnNN Disable Reset – line number NN is enabled (disable state exited);
- LnNN Test – line number NN enters Test condition;
- LnNN Test Reset – line number NN exits Test condition;

- cONN Interrupt – controllable output number NN enters Fault condition: Interrupted controllable output;
- cONN Short – controllable output number NN enters Fault condition : Short circuit in controllable output;
- cONN Normal– controllable output number NN restored from Fault condition;
- cONN Disable – controllable output number NN disabled;
- cONN Disable Reset – controllable output number NNN enabled (disable state exited)
- Fault Main Power – fire control panel enters Fault condition: Interruption in mains supply;
- Flt.Mn.Power Reset – fire control panel exits Fault condition: Interruption in mains supply;
- Fault Battery – fire control panel enters Fault condition: Fault in backup battery supply ;
- Flt Battery Reset - fire control panel exits Fault condition: Fault in backup battery supply;
- Fault AuxiliaryPower – fire control panel enters Fault condition: Fault in auxiliary supply for external devices in Basic Module – fuse activated;
- Flt AuxPower Reset – fire control panel exits Fault condition: Fault in auxiliary supply for external devices in Basic Module – fuse activated
- Fault Earth – fire control panel enters Fault condition: Short circuit to grounded wire;
- Fault Earth Reset – fire control panel exits Fault condition: Short circuit to grounded wire;
- Fault Lines Power 1 – fire control panel enters Fault condition: Fault in positive supply to lines in Basic Module;
- Flt LnPower1 Reset – fire control panel exits Fault condition: Fault in positive supply to lines in Basic Module;
- Fault Line Power 2 – fire control panel enters Fault condition: Fault in positive supply to lines in Additional Module;
- Flt LnPower2 Reset – fire control panel exits Fault condition: Fault in positive supply to lines in Additional Module;
- Fault NegativePower1 – fire control panel enters Fault condition: Fault in negative supply to lines in Basic Module;
- Flt NgPower1 Reset – fire control panel exits Fault condition: Fault in negative supply to lines in Basic Module;
- Fault NegativePower2 – fire control panel enters Fault condition: Fault in negative supply to lines in Additional Module;
- Flt NgPower2 Reset – fire control panel exits Fault condition: Fault in negative supply to lines in Additional Module;
- Fault Outs Power 1 – fire control panel enters Fault condition: Fault in supply to external devices in Basic Module;
- Flt Out Pwr1 Reset – fire control panel exits Fault condition: Fault in supply to external devices in Basic Module;
- Fault Outs Power 2 – fire control panel enters Fault condition: Fault in supply to external devices in Additional Module;
- Flt Out Pwr2 Reset – fire control panel exits Fault condition: Fault in supply to external devices in Additional Module;
- Fault Code 2 – fire control panel enters Fault condition: Fault in the program of Linear processor 2;

- Fault Code 2 Reset – fire control panel exits Fault condition: Fault in the program of Linear processor 2;
- Fault Code 3 – fire control panel enters Fault condition: Fault in the program of Linear processor 3;
- Fault Code 3 Reset – fire control panel exits Fault condition: Fault in the program of Linear processor 3;
- Fault Data 2 – fire control panel enters Fault condition: Fault in data of Linear processor 2;
- Fault Data 2 Reset – fire control panel exits Fault condition: Fault in data of Linear processor 2;
- Fault Data 3 – fire control panel enters Fault condition: Fault in data of Linear processor 3;
- Fault Data 3 Reset – fire control panel exits Fault condition: Fault in data of Linear processor 3;
- Fault Timer – fire control panel enters Fault condition: Real time clock failed;
- Fault Timer Reset – fire control panel exits Fault condition: Real time clock failed
- Fault DataEEPROM – fire control panel enters System fault: Wrong record in internal EEPROM of Processor 1;
- Fault Code 1 – fire control panel enters System fault: Fault in the program of Processor 1;
- Fault Data 1 – fire control panel enters System fault : Fault in the data of Processor 1;
- Fault Display – fire control panel enters System fault: Display failed;
- New configuration – fire control panel enters System fault : New configuration;
- Battery Low – fire control panel enters Fault condition : Battery low;
- Reset Panel – initial reset of the fire control panel after start up or after exit of Adjustment Mode;
- Manual Set Param – enter SetUp Mode;
- Remote Set Param – enter Remote mode for setting the fire control panel parameters or line parameters via the interface;
- Battery Off – back up batteries switched off due to interruption in mains supply;
- Watchdog Reset – the protection timer of the fire control panel is triggered.

Press and hold the button  to display information screen for event's date and time:

(The field "HH:MM:SS" contains hour, minutes and seconds;
"DD-MM-YY" contains day, month and year)

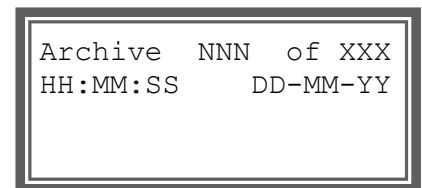

The screen is visualized when button  is being pressed and hold.





14. SetUp Mode

14.1. Description





SetUp Mode is used for setting configuration parameters of a fire control panel. Access is provided through the screen of Information and Control Mode, menu System functions, submenu SetUp (see section 13 - Information and Control Mode). When the fire control panel enters SetUp Mode, it exits all other modes or conditions and the registered configuration is saved in the energy independent memory. Upon exit of SetUp Mode the unit is reset.

When the fire control panel operates in SetUp Mode it does not serve fire alarm lines, controllable outputs and the other periphery devices (all lines and outputs are switched off); the fire control panel is controlled via the keypad for mode operation.

In this condition only the green LED indicator illuminates  (Power supply). The local sounder is switched off.

The screens displayed on the LCD are organized in a tree structure of subordinate menus (Appendix 2d). The first two lines display the name of the current menu (or function); the bottom two lines display the names of the subordinate menu (or the parameter or command). When the bottom lines display subordinate menus, the arrow over the first position indicates which menu or function will be activated when you press button . Transition to a menu of previous (higher) level is performed by pressing the button . Moving between menus of one and the same level is performed by pressing the buttons  and .

The screens for parameters change and command execution (command screens) are on the last (lowest) level. When a screen for change in parameters or a command screen is activated, a cursor appears. In this case the buttons have the following operation:

- Press button  to save a change in a parameter or to execute a selected command; afterwards the screen is deactivated and the cursor disappears (differences in button's effect in some cases are explicitly stated);
- Press button  to deactivate the screen without saving any changes or without execution of the relevant command; the cursor disappears;
- Button  is active only on screens for parameter change. Press the button when:
 - ◆ The cursor selects a digit – then the cursor will move with one position to the right. When the last position is reached, the cursor moves back to the first position;
 - ◆ The cursor is to the right of the parameter – then the parameter will decrease its value to the next lower possible value. When the lowest value is reached, the cursor moves back to the highest possible value of the parameter;
- Button  operates only on screens for parameter change. Press it to increase the selected digit with one step or to increase the parameter to the next possible rate (when the cursor is to the right of the parameter). In both cases, when the maximum possible rate is reached, a transition to the lowest possible rate is made

14.2. Access to SetUp Mode

Enter the mode through activation of System functions, submenu Set Parameters (see section 13.7.9).

SetUp Mode has Access Level 3A and to enter it you need to use a password. For this purpose when you enter menu SetUp, the following screen appears and the cursor is positioned over the first digit 0000 (password):

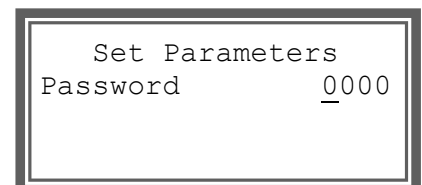

When the desired password is already set, press button  and, if the value is correctly entered (matches with the preset password), the fire control panel enters SetUp Mode.

Access to level 3A is then provided and the subordinate menus and functions, included in menu SetUp, are now accessible:

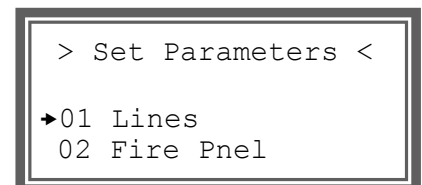

14.3. Menus

The menu contains the following subordinate menus and functions:

- 01 Line parameters
- 02 Fire control panel parameters
- 03 Adjustment of controllable outputs
- 04 Adjustment of relay outputs
- 05 Default parameters
- 06 Clear archive
- 07 Enter new password

14.3.1. Menu *Line parameters*

Select the menu from the screen:

```
> Set Parameters <
▶01 Lines
  02 Fire Panel
```

The menu contains up to 32 subordinate menus, one for each line (for lines that do not exist in this particular configuration no menu is displayed):

```
> Set Parameters <
  > Lines <
▶01 Line 01
  02 Line 02
```

When the menu for a particular line is activated a screen with the submenu for the parameters appears:
(The field "NN" contains the number of the selected line)

```
> Set Parameters <
  > Line NN <
▶01 Number Checks
  02 Check RmvdFD
```

Each of the subordinated menu contains command screens or menus for the following line parameters:

- 01 Number of confirmation checks for Fire condition:
The field "X" contains the number of checks - 1 to 3.

```
> Set Parameters <
  > Line NN <

Number Checks      X_
```

Repeated checks (two or three) are usually set for fire detectors that shall respond two or three times before a decision for Fire condition is made. In this case the time for the second and third check is included in the response time of the detector, not in the response time of the control panel.

- 02 Check for removed fire detectors:
When the field "XX" contains "No", check for removed fire detectors is not performed; when it contains "Yes", the check is performed.

```
> Set Parameters <
  > Line NN <

Check RmvdFD      XX_
```

The check is feasible when the fire detectors are connected in compliance with the connection diagram in Appendix 5a. The check is performed every 8 seconds by applying 5V voltage of reverse polarity on the line.

- 03 Period for transition from Fire condition stage I to Fire condition stage II:
"SSS" contains the period in seconds - 0 to 255s.

```
> Set Parameters <
  > Line NN <

Time F1-F2        SSSs
```

04 Current threshold above which Fire condition stage I is detected in a line:

“CCC” contains the current in mA - 1 to 80mA.

```
> Set Parameters<
> Line NN <

Current Fire1  CCmA
```

05 Current threshold above which Fire condition stage II is detected in a line:

“CCC” contains the current in mA - 1 to 80mA.

```
> Set Parameters <
> Line NN <

Current Fire2  CCmA
```

06 Current threshold above which Short circuit is detected in a line:

“CCC” contains the current in mA - 1 to 80mA.

```
> Set Parameters <
> Line NN <

Current Short  CCmA
```

07 Current threshold below which a break in a line is detected:

“CCC” contains the current in mA - 1 to 80mA.

```
> Set Parameters <
> Line NN <

Current Interr CCmA
```





08 Logical AND in a line

The field “XX” may contain 00 (the current line is not in Logical AND dependency by another line) or a digit from 01 to 32 (number of the line in Logical AND dependency by the current line) – see 6.3.

```
> Set Parameters <
> Line NN <

Logical AND    XX
```

The modification of parameter Logical AND has the following special features:

- ◆ A line can not be set to Logical AND dependency by itself – button  is not active in this case;
- ◆ A line can not be set to Logical AND dependency by a line that has already been set to such dependency by a third line – button  is not active in this case either;
- ◆ A line can not be set to Logical AND dependency by a line that does not exist in the current configuration (for example dependency on Line 31 and the configuration has 24 lines) – button  is not active in this case either;
- ◆ A line can not be set to Logical AND dependency by a line connected to another Module (lines 1-16 are connected to the Basic module, Lines 17-32 are connected to the Additional module) – button  is not active in this case;
- ◆ Where a line is set to Logical AND dependency by another line, the second line is automatically set to the same dependency by the first line – in the parameter Logical AND of the second line is saved the number of the first line;
- ◆ Where a line exits the Logical AND dependency, the second line exits the dependency by the first line too – in the parameter Logical AND of the line is saved “0”;
- ◆ The Logical AND dependency can cover only two fire alarm lines – if, before the modification of the parameter Logical AND, it contained a number of a third line, the third line automatically exits the dependency (in the third line’s parameter Logical AND is saved “0”).

09 Menu Controllable outputs in Fire condition stage II in the line



Select the menu from the screen:

```

> Set Parameters <
  > Line  NN <
  ▶09 Ctrl Outs F2
    10 Relays F1

```

The menu contains 1 or 2 parameters depending on the available controllable outputs. The parameter pointed by the cursor will be changed. To move between the parameters

use button ; to change a parameter use button .

```

> Set Parameters <
  > Line  NN <
  F2 Ctrl Out 01   XX_
  F2 Ctrl Out 02   XX_

```

When the field "XX" contains "No" the controllable output will not be activated in Fire condition stage II; when the field contains "Yes", the controllable output will be activated.

10 Menu Relay outputs in Fire condition stage I in the line

Select the menu from the screen:

```

> Set Parameters <
  > Line  NN <
  ▶10 Relay F1
    11 Relay F2

```

The menu contains 2, 10 or 18 parameters depending on the available relay outputs in this particular configuration. The parameter pointed by the cursor will be changed. To

move between the parameters use button ; to change

a parameter use button .

```

> Set Parameters <
  > Line  NN <
  F1 Relay 01      XX_
  F1 Relay 02      XX_

```

When the field "XX" contains "No" the relay output will not be activated in Fire condition stage I; when the field contains "Yes", the relay output will be activated.

11 Menu Relay outputs in Fire condition stage II in the line

Select the menu from the screen:

```

> Set Parameters <
  > Line  NN <
  ▶11 Relay F2
    12 Message

```

The menu contains 2, 10 or 18 parameters depending on the available relay outputs in this particular configuration. The parameter pointed by the cursor will be changed. To

move between the parameters use button ; to change

a parameter use button .

```

> Set Parameters <
  > Line  NN <
  F2 Relay 02      XX_
  F2 Relay 03      XX_

```

When the field "XX" contains "No" the relay output will not be activated in Fire condition stage II; when the field contains "Yes", the relay output will be activated.

Relay output 1 will always be activated in Fire condition stage II and thus it is not accessible for changes.

12 Text message for the line:

(The field "TTTTTTTTTTTTTTTTTTTT" contains text message.)

At first the cursor is positioned over first symbol of the message. To move the cursor use button ; to change

a symbol use button .

```

> Set Parameters <
  > Line  NN <
  Message
  TTTTTTTTTTTTTTTTTT

```

The following symbols are used:

Space А В Г Д Е Ж З И Й К Л М Н О П Р С Т У Ф Х Ц Ч Ш Щ Ъ Ю Я Ё Ы Э ! " # \$ % & ' () *
+ , - . / 0 1 2 3 4 5 6 7 8 9 : ; < = > ? @ A B C D E F G H I J K L M N O P Q R S T U V W X Y Z

14.3.2. Menu *Fire control panel parameters*

Select the menu from the screen:

```
> Set Parameters <
▶02 Fire Panel
03 Ctrl Outs
```

The menu contains 5 screens for setting the parameters of the control panel and one submenu:

```
> Set Parameters <
> Fire Panel <
▶01 Inspection time
02 Interface Nmb
```

01 Inspection time:

(The field "SSS" contains the time in seconds - from 0 to 255s, - that is added to the time for proceeding from Fire condition stage I to Fire condition stage II in the lines, when

button  is pressed.)

```
> Set Parameters <
> Fire Panel <
Inspection time SSSs
```

02 Interface number:

(The field "NNNN" contains the address for data exchange via interface - from 0000 to 9999)

```
> Set Parameters <
> Fire Panel <
Interface Nmb NNNN
```

03 Baud rate:

(The field "BBBB" is the baud rate of exchange via interface (bits in second) - 1200, 2400, 4800 or 9600 bd);

```
> Set Parameters <
> Fire Panel <
Baud Rate BBBBbd_
```

04 Modem supported:

(When the field "XX" contains "No", a modem is not supported via interface RS232, when it contains "Yes" a modem is supported)

```
> Set Parameters <
> Fire Panel <
Modem XX_
```

05 Menu Phone numbers:

The menu is provided for saving phone numbers that will be dialed by the modem if a particular event occurs in the control panel.

```
> Set Parameters <
> Fire Panel <
▶01 Tel number 01
02 Tel number 02
```

It contains 4 screens for parameters, one for each phone number:

(The field "N" contains the consecutive number of the phone number;

"IIII" contains the type of dialing – pulse or tone;

"TTTTTTTTTTTTTTTTTTTT" contains the phone number)

```
> Set Parameters <
> Fire Panel <
Tel number N IIII_
TTTTTTTTTTTTTTTTTTTT
```

In the field provided for the phone number may be entered a maximum of 20 symbols, like space, '#', '*', comma and digits from 0 to 9. The space is intended to provide a better legibility and is not saved in the memory. If the phone number consists only of spaces it will be erased.

If all four phone numbers are erased, the modem will not be able to connect if an event is registered by the control panel.

06 Language:

(The field "XXXXXXXX" contains the language for the text message – Bulgarian, English or Russian)

```
> Set Parameters <
> Fire Panel <

Language XXXXXXXXXXXX_
```

14.3.3. Menu *Adjustment of controllable outputs*

Select the menu from the screen:



```
> Set Parameters <

▶03 Ctrl Outs
04 Relays
```

The menu allows the user to trigger each of the available controllable outputs for setup purposes. When you enter the menu the cursor is positioned over the line of Controllable output 1 and no controllable output is active:

```
> Set Parameters <
> Ctrl Outs <
Ctrl Out 01 No_
Ctrl Out 02 No_
```

When you press button  the controllable output on the selected line will be activated. Simultaneously the inscription "No" changes into "Yes". When you press the same button once again, the controllable output will be deactivated and the inscription changes to "No".

To move the cursor between the lines use buttons  and . If activated controllable output is available at the same time it will be deactivated.

To deactivate the function use button . If activated controllable output is available at the same time it will be deactivated.

14.3.4. Menu *Adjustment of relay outputs*

Select the menu from the screen:



```
> Set Parameters <

▶04 Relay
05 Default param
```

The menu allows the user to trigger each of the available relay outputs for setup purposes. When you enter the menu the cursor is positioned over the line of Relay output 1 and no relay output is active:

```
> Set Parameters <
> Relays <
Relay 01 No_
Relay 02 No_
```

When you press button  the relay output on the selected line will be activated. Simultaneously the inscription "No" changes into "Yes". When you press the same button once again, the relay output will be deactivated and the inscription changes to "No".

To move the cursor between the lines use buttons  and . If activated relay output is available at the same time it will be deactivated.

To deactivate the function use button . If activated relay output is available at the same time it will be deactivated.

14.3.5. Function *Default parameters*

Select the function from the screen:

```
> Set Parameters <
▶05 Default param
06 Clear archive
```

While selecting the function a screen for confirmation will appear:

```
> Set Parameters <
> Default param <
≡ - Confirm
x - Cancel
```

When you press button  the function is activated and the message *Please wait...* appears on the screen:

```
> Set Parameters <
> Default param <

Please wait...
```

Upon activation of the function the following default parameters are saved in the energy independent memory:

- Line parameters:
 - ◆ Number of reviews - 2;
 - ◆ Check up for a removed fire detector - activated;
 - ◆ Period for transition from Fire condition stage I to Fire condition stage II - 120s;
 - ◆ Current threshold above which Fire condition stage I in a line is detected - 12mA;
 - ◆ Current threshold above which Fire condition stage II in a line is detected - 40mA;
 - ◆ Current threshold above which Short circuit in a line is detected - 70mA;
 - ◆ Current threshold below which Break in a line is detected - 3mA;
 - ◆ Logical AND of a line – not set;
 - ◆ Controllable outputs upon Fire condition stage I in a line – will not operate;
 - ◆ Controllable outputs upon Fire condition stage II in a line – will not operate;
 - ◆ Relay outputs upon Fire condition stage I in a line – will not operate;
 - ◆ Relay outputs upon Fire condition stage II in a line – only Relay output 1 will be activated;
- Fire control panel parameters:
 - ◆ Inspection time - 120s;
 - ◆ Interface number - 1234;
 - ◆ Baud rate - 9600bd;
 - ◆ Modem – no modem;
- Lines in test condition – no such lines;
- Disabled lines – no such lines;
- Disabled controllable outputs – no such outputs.
- Mode of operation- Day Mode.

14.3.6. Function *Clear archive*

Select the function from the screen:

```
> Set Parameters <
▶06 Clear archive
07 New password
```

While selecting the function a screen for confirmation will appear:

```
> Set Parameters <
> Clear archive <
≡ - Confirm
x - Cancel
```

When you press button  the function is activated and the archive (information on events saved in the energy-independent memory of the control panel) will be cleared.

The fire counter is not cleared here. Reset of the fire counter is possible in a special mode only, Access level 4.

14.3.7. Function *Enter new password*

Select the function from the screen:

```
> Set Parameters <
06 Clear archive
→07 New password
```

When the function is activated appears the following screen and the cursor is positioned over the first digit of 0000 (password):

```
> Set Parameters <
New password 0000
```

The function allows the user to enter a new password for access to SetUp Mode.

15. Remote Control Mode

15.1. Description

The fire control panel enters Remote Control Mode when an external control unit of higher level (computer from a centralized dispatcher control point or other) sets the panel's configuration parameters via serial interface. In this case the fire control panel exits all other modes/conditions. When the fire control panel operates in Remote Control Mode, it does not serve fire alarm lines, controllable outputs either other periphery devices (all lines and outputs are switched off); it is under the control of the external unit. When the fire control panel exits the mode, initial reset is being done

15.2. Indication

15.2.1. LED and sound indication

In this mode indicator  (Fault condition) illuminates in continuous yellow light, the local sounder is switched off.

15.2.2. Text message

The following screen is displayed:

```
Remote control
```

15.3. Using the keypad

No buttons are active in this mode.

16. Saving the parameters

All set parameters or modes of operation are being saved in the energy independent memory and upon interruption of mains or backup battery supply they remain unchanged. When the fire control panel is powered again, it operates according the preset parameters and modes. The default parameters and modes are factory set (see section 14.3.5). The user password is set to 0000

17. Labour protection requirements

The installation and maintenance staff shall be well grounded in equipment's mechanism and operation, as well as in common technical safety regulations.

Connection to unearthed or to indirectly earthing mains supply is prohibited.

Troubleshoots are to be cleared after disconnecting the feeding cable from the mains supply.

The control panel is designed for installing in premises with a normal fire hazard, as per the Fire Precaution Technical Regulations in Building Construction

18. Installation and arrangements

When fire detectors and periphery devices are integrated in the system, avoid arranging wires in closed loops; it will reduce the control panel's resistance to electro magnetic interferences

18.1. To mount the fire control panel

- unpack the device;
- put the dowels on the determined places;
- fasten the control panel to the dowels through the three holes provided on the chassis.

18.2. Periphery devices assembly

All connections are to be made by means of terminals, mounted on the printed circuit boards (Appendix 4). Be advised, that the consumption of the voltage powering the external devices (terminal "+ 28V" on the Basic Module) shall not exceed 1.5A in heavy duty mode.

18.2.1. Mounting periphery devices to controllable outputs

Terminals "+Out1", "-Out1", "+Out2", "-Out2" of the Basic Module and "+Out2", "-Out2" of the Additional Module are used – controllable, potential outputs, responding upon Fire condition stage II (depending on the pre-programming of the relation fire alarm line – controllable outputs).

Use the special connection diagram for the executive device provided in Appendix 5c.

End of line resistors 5k6 are connected directly to the terminals of the unused controllable outputs.

18.2.2. Mounting periphery devices to relay outputs

The following terminals are used:

- Terminal "+28V" of the Basic module – positive lead of the stabilized direct current supplying the external devices (light and sound signaling devices, executing devices and others);
- Terminal "GND" of the Basic module – chassis ground (negative lead of the stabilized direct current supplying the external devices);
- Terminals "Rel1/C", "Rel1/NO", "Rel1/NC", "Rel2/C", "Rel2/NO" и "Rel2/NC" of circuit board 5200Basic, Basic Module – potential free relay contacts, responding at Fire condition stage I or Fire condition stage II (in compliance with the pre-programming of the relation fire alarm line – relay outputs);
- Terminals "Rel3", to "Rel10" of Module 5203, Basic Module – potential free relay contacts, responding at Fire condition stage I or Fire condition stage II (in compliance with the pre-programming of the relation fire alarm line – relay outputs). The type of the contact at "Rel3" to "Rel10" (normally open NO or normally closed NC) is set through the microswitches of Module 5203 (Appendix 4f);
- Terminals "Rel3", to "Rel18" of Module 5204, Basic Module – potential free relay contacts, responding at Fire condition stage I or Fire condition stage II (in compliance with the pre-programming of the relation fire alarm line – relay outputs). The type of the contact at "Rel3" to "Rel18" (normally open NO or normally closed NC) is set through the microswitches of Module 5204 (Appendix 4g);
- Terminals "REL Fault/C", "REL Fault/NO" and "REL Fault/NC" of Basic Module - potential free relay contacts. Where no fault condition is registered, terminals "REL Fault/C" and "REL Fault/NO" are connected; upon fault condition terminals "REL Fault/C" and "REL Fault/NC" are connected.

The executive device shall be connected according to Appendix 5 d. Unused relay outputs remain unoccupied.

18.3. Connecting interface units

To connect interface units you need a fire control panel with basic module that supports RS232 or RS485 serial interface (delivered upon customer's order). The interface units are connected to one of the two interfaces, by means of 9 - lead coupling, available on Interface Module. Signals distribution is shown in B Table 3.

Table 3

Coupling's lead	Signal of RS232 Interface	Signal of RS485 Interface
2	RXD (input data)	Inverting input/output
3	TXD (output data)	Non inverting input/output
4	DTR	
5	GND (chassis ground)	

The fire control panel provides power supply to an external modem, if the feature has been included in the order. The power supply is tapped on a two-pole terminal on the module Modem Supply.

18.4. Connecting fire detectors

Fire detectors are connected to the fire control panel by means of two-wire insulated line of total resistance up to 100Ω. Connection is made to the terminal of the corresponding modules (Appendix 4) – “+L N” and “-L N”, observing the indicated polarity.

Automatic fire detectors of series FD3000 and FD8000 or compatible can be used (Appendix 5a). To enable detection of Fault condition *Removed fire detector* diodes shall be mounted – for example 1N5819, to the indicated in Appendix 5a direction. To set up a fire alarm line with group addressing of manual call points and automatic fire detectors you can use FD3050 Manual Call Point or compatible (Appendix 5b).

Up to 32 fire detectors can be integrated in one fire alarm line regardless of their type.

End of line resistors 3k9 are connected directly to the terminals of unused fire alarm lines.

18.5. Connection to power supply

Take out the fuse from the terminal with fuse (Appendix 3).

Connect a feeding cable to the terminal with fuse, observing the following positions (Appendix 3):

- P – power wire “Phase”;
- N – power wire “Null”;
- Ω – safety ground wire.

The cable shall be double insulated and of 0,5mm² section for the power supply wires, and of 1,5mm² section for the safety ground wire.

The other end of the feeding cable is connected to the mains power supply by means of junction box.

The mains power supply of the fire control panel shall be in a separate loop.

19. Fire control panel start up

Make sure that the connection to mains power supply is properly made.

Make sure that the periphery devices are correctly connected.

Place the fuse in the terminal with fuse, the display illuminates and appears the text:

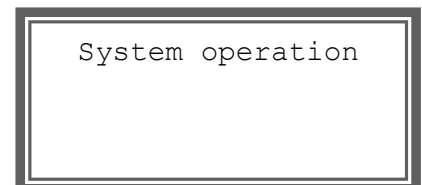

Connect the feeding cable and the backup batteries; the batteries shall be in a series connection.

Connect the red wire to the positive backup battery pole, and the blue wire - to the negative pole. The overall voltage of both batteries shall not exceed 17.6V; otherwise the fire control panel will not recognize them.

Enter SetUp Mode and set the common parameters and line parameters. When the fire control panel exits SetUp Mode, it proceeds to System operation and enters Duty Mode – the unit is ready to provide site protection.

20. Change in fire control panel configuration

20.1. How to add or remove Additional Module

Fire control panel FS5200 is able to operate with one additional module having 8 or 16 fire alarm line.

To add an additional module, follow the instructions:

- a) Open the fire control panel and cut off the power supply by taking the fuse out of the terminal with fuse (Appendix 3) and disconnecting the feeding cables of the backup batteries ;
- b) Connect the available ribbon cable to the connector of module 5202, Basic Module, and to the connector of circuit board 5200 Base, Basic Module (Appendix 6);
- c) Fix the Additional Module in a way that the stud on the panel's bottom enters the provided hole on the module and the restricting strap on the panel's bottom is in opposite direction of the module's slot (Appendix 6);
- d) Slide the Additional Module down until rest (Appendix 6);
- e) Drive the available Special nut onto the stud on the panel's bottom, provided for additional modules and screw until rest (Appendix 6);
- f) Connect the provided ground wire to the ground terminals of the module and to the bottom of the panel (Appendix 6);
- g) Connect the fire alarm lines or the executive devices to the newly added module (Appendix 4);
- h) Restore the power supply of the fire control panel by placing the fuse back in the terminal with fuse (Appendix 3), connect the feeding cables to the backup batteries and close the fire control panel;
- i) The fire control panel proceeds to System operation and enters Fault condition: New configuration;
- j) Enter SetUp Mode and if necessary, re-configure the fire control panel. When SetUp Mode is exited, the control panel runs again system operations and enters Duty Mode;
- k) The unit is ready to provide site protection.

To remove an additional module, follow the instructions:

- a) Open the fire control panel and cut off the power supply by taking the fuse out of the terminal with fuse (Appendix 3) and disconnecting the feeding cables of the backup batteries;
- b) Disconnect the fire alarm lines or executive devices from the module you want to remove;
- c) Disconnect the ground wire and the ground terminals of the module and of the panel bottom (Appendix 6);
- d) Unscrew the Special nut (Appendix 6);
- e) Slide the Additional Module upwards so that the restricting strap on the panel's bottom enters the module's slot (Appendix 6);
- f) Take the Additional Module out;
- g) Disconnect the module's ribbon cable from the connector of the Basic Module (Appendix 6);
- h) Restore the power supply of the fire control panel by placing the fuse back in the terminal with fuse (Appendix 3), connect the feeding cables to the backup batteries and close the fire control panel;
- i) The fire control panel proceeds to System operation and enters Fault condition: New configuration;
- j) Enter SetUp Mode and if necessary, re-configure the fire control panel. When SetUp Mode is exited, the control panel runs again system operations and enters Duty Mode;
- k) The unit is ready to provide site protection.

20.2. Change in Basic Module

The following changes can be made in Basic Module:

- Add Module 5201 (8 fire alarm lines);
- Add Module 5203 (8 relay outputs for fire condition) or Module 5204 (16 relay outputs for fire condition);
- Remove Module 5201 (8 fire alarm lines);

- Remove Module 5203 (8 relay outputs for fire condition) or Module 5204 (16 relay outputs for fire condition);
- Replace Module 5203 (8 relay outputs for fire condition) with Module 5204 (16 relay outputs for fire condition);
- Replace Module 5204 (16 relay outputs for fire condition) with Module 5203 (8 relay outputs for fire condition).

To add Module 5201, 5203 or 5204 follow the instructions:

- a) Open the fire control panel and cut off the power supply by taking the fuse out of the terminal with fuse (Appendix 3) and disconnecting the feeding cables of the backup batteries;
- b) Place Module 5201, 5203 or 5204 in a way that the coupling connects the corresponding coupling of circuit board 5200Base (Appendix 4a);
- c) Fix Module 5201, 5203 or 5204 using the available screws and washers M3;
- d) Connect the fire alarm lines or the executive devices to the newly added module (Appendix 4);
- e) Restore the power supply of the fire control panel by placing the fuse back in the terminal with fuse (Appendix 3), connect the feeding cables to the backup batteries and close the fire control panel;
- f) The fire control panel proceeds to System operation and enters Fault condition: New configuration;
- g) Enter SetUp Mode and if necessary, re-configure the fire control panel. When SetUp Mode is exited, the control panel runs again system operations and enters Duty Mode;
- h) The unit is ready to provide site protection.

To remove Module 5201, 5203 or 5204 from Basic Module follow the instructions:

- a) Open the fire control panel and cut off the power supply by taking the fuse out of the terminal with fuse (Appendix 3) and disconnecting the feeding cables of the backup batteries;
- b) Disconnect the fire alarm lines or the executive devices from the module you wish to remove;
- c) Remove the M3 screws of Module 5201, 5203 or 5204 and remove the module (Appendix 4a);
- d) Restore the power supply of the fire control panel by placing the fuse back in the terminal with fuse (Appendix 3), connect the feeding cables to the backup batteries and close the fire control panel;
- e) The fire control panel proceeds to System operation and enters Fault condition: New configuration;
- f) Enter SetUp Mode and if necessary, re-configure the fire control panel. When SetUp Mode is exited, the control panel runs again system operations and enters Duty Mode;
- g) The unit is ready to provide site protection.

To replace Module 5203 with Module 5204 (or Module 5204 with Module 5203) follow the instructions:

- Remove the old module – follow operations a) – c);
- Add the new module – follow operations b) – h).

20.3. Changes in Additional Module

The following changes can be made to Additional Module:

- Add Module 5201 (8 fire alarm lines);
- Remove Module 5201 (8 fire alarm lines).

To add Module 5201 follow the instructions:

- a) Open the fire control panel and cut off the power supply by taking the fuse out of the terminal with fuse (Appendix 3) and disconnecting the feeding cables of the backup batteries;
- b) Place Module 5201 in a way that the coupling connects the corresponding coupling of Module 5202 to enter the coupling of Module 5201 (Appendix 4b);
- c) Fix Module 5201 with the available screws and washers M3;
- d) Connect the fire alarm lines to the newly added module (Appendix 4);

- e) Restore the power supply of the fire control panel by placing the fuse back in the terminal with fuse (Appendix 3), connect the feeding cables to the backup batteries and close the fire control panel;
- f) The fire control panel proceeds to System operation and enters Fault condition: New configuration;
- g) Enter SetUp Mode and if necessary, re-configure the fire control panel. When SetUp Mode is exited, the control panel runs again system operations and enters Duty Mode;
- h) The unit is ready to provide site protection.





To remove Module 5201 from Additional Module follow the instructions:

- a) Open the fire control panel and cut off the power supply by taking the fuse out of the terminal with fuse (Appendix 3) and disconnecting the feeding cables of the backup batteries;
- b) Disconnect the fire alarm lines from Module 5201;
- c) Unscrew the M3 screws that fix Module 5201 and remove the module (Appendix 4b);
- d) Restore the power supply of the fire control panel by placing the fuse back in the terminal with fuse (Appendix 3), connect the feeding cables to the backup batteries and close the fire control panel;
- e) The fire control panel proceeds to System operation and enters Fault condition: New configuration;
- f) Enter SetUp Mode and if necessary, re-configure the fire control panel. When SetUp Mode is exited, the control panel runs again system operations and enters Duty Mode;
- g) The unit is ready to provide site protection.

21. Troubleshooting

Possible problems and methods of troubleshooting are described in Table 4.

Table 4

Trouble	Indication	Troubleshooting
Fatal System fault (except for New configuration)	Indicators  and  illuminate in steady yellow light; the local sounder releases continuous signal; the message <i>System Fault</i> is displayed;	The trouble shall be fixed in Service department
New configuration	Indicator  flashes in yellow light, indicator  illuminates in continuous yellow light; local sounder produces discontinuous signal, the message <i>New configuration</i> appears on the screen	Enter SetUp Mode. Exit the mode and if the problem persists, it shall be fixed in Service department
Low backup batteries due to interrupted mains power supply	The local sounder releases discontinuous signal (1s sound, 3s pause); the message <i>Battery Low</i> appears on the screen; the backlight of the display is off	Restore the mains power supply or replace the backup batteries
Fault in a line	Indicator  flashes in yellow light; the local sounder releases discontinuous signal; the message <i>Fault in Line</i> appears on the screen	<ul style="list-style-type: none"> - Eliminate the fault (short circuit, interruption or removed fire detector); - In Fault condition: Removed FD check for short circuit in a component to a ground wire (see <i>Fault condition: Short circuit to ground wire</i>)









Trouble	Indication	Troubleshooting
Fault in a controllable output	Indicators  and  ; illuminate in steady yellow light; the local sounder releases discontinuous signal; a message appears on the display indicating the controllable output and the type of the fault	<ul style="list-style-type: none"> - Eliminate the fault (short circuit or interruption) in the transmission path of the controllable output or in the executive device; - Upon <i>Fault condition: Interruption</i> check for short circuit in component of the controllable output to ground wire (see <i>Fault condition: Short circuit to ground wire</i>)
Fault in mains power supply	Indicators  and  illuminate in steady yellow light; the local sounder releases discontinuous signal; the message "Fault Mn Power" appears on the display	<ul style="list-style-type: none"> - Restore the mains power supply; - Replace the burnt fuse Fu1 – 4A (Appendix 3)

Table 4 - continued

Trouble	Indication	Troubleshooting
Fault in backup battery supply	Indicators  and  illuminate in steady yellow light, the local sounder releases discontinuous signal; the message "Fault Battery" appears on the display	<ul style="list-style-type: none"> - Place or replace the backup batteries; - Replace the burnt fuse Fu2 – 4A (Appendix 3)
Fault in power supply to external devices	Indicator  flashes in yellow light; the local sounder releases discontinuous signal; the message <i>Fault Mn Power</i> appears on the display	Eliminate overload of power supply to external devices
Short circuit to ground wire	Indicator  flashes in yellow light; the local sounder releases discontinuous signal; the message <i>Fault Earth</i> appears on the display	Eliminate the short circuit
Fault in internal power supply	Indicator  flashes in yellow light; the local sounder releases discontinuous signal; the message <i>Fault Mn Power</i> appears on the display	The fault shall be fixed in Service department

22. Conditions of operation, storage and transportation

22.1. Operation and storage

The fire control panel shall operate and be kept in closed premises, under the following conditions:

22.1.1. Temperature

- storage - from 5°C to 35°C
- transportation - from minus 10°C to 50°C
- operation - from minus 5°C to 40°C

22.1.2. Relative humidity

- storage - up to 80%
- operation - up to 93%

22.2. Transportation

The fire control panel shall be transported by vehicles, in factory packing, in the above stated environmental conditions and at sinusoidal vibrations with acceleration amplitude not more than $4,9\text{m/s}^2$ in frequency range 10 to 150Hz.

23. Warranty

The producer guarantees compliance of the unit with EN 54-2:1997/A1:2006/AC: 2009, EN 54-4:1997/A2: 2006/AC 2009. The warrant period is 24 months from the date of the purchase, providing that

- the conditions of storage and transportation have been observed;
- the startup has been done by authorized personnel only;
- the requirements for operation stated herein have been observed.

UniPOS wishes you a successful work!

24. Appendixes

Appendix 1

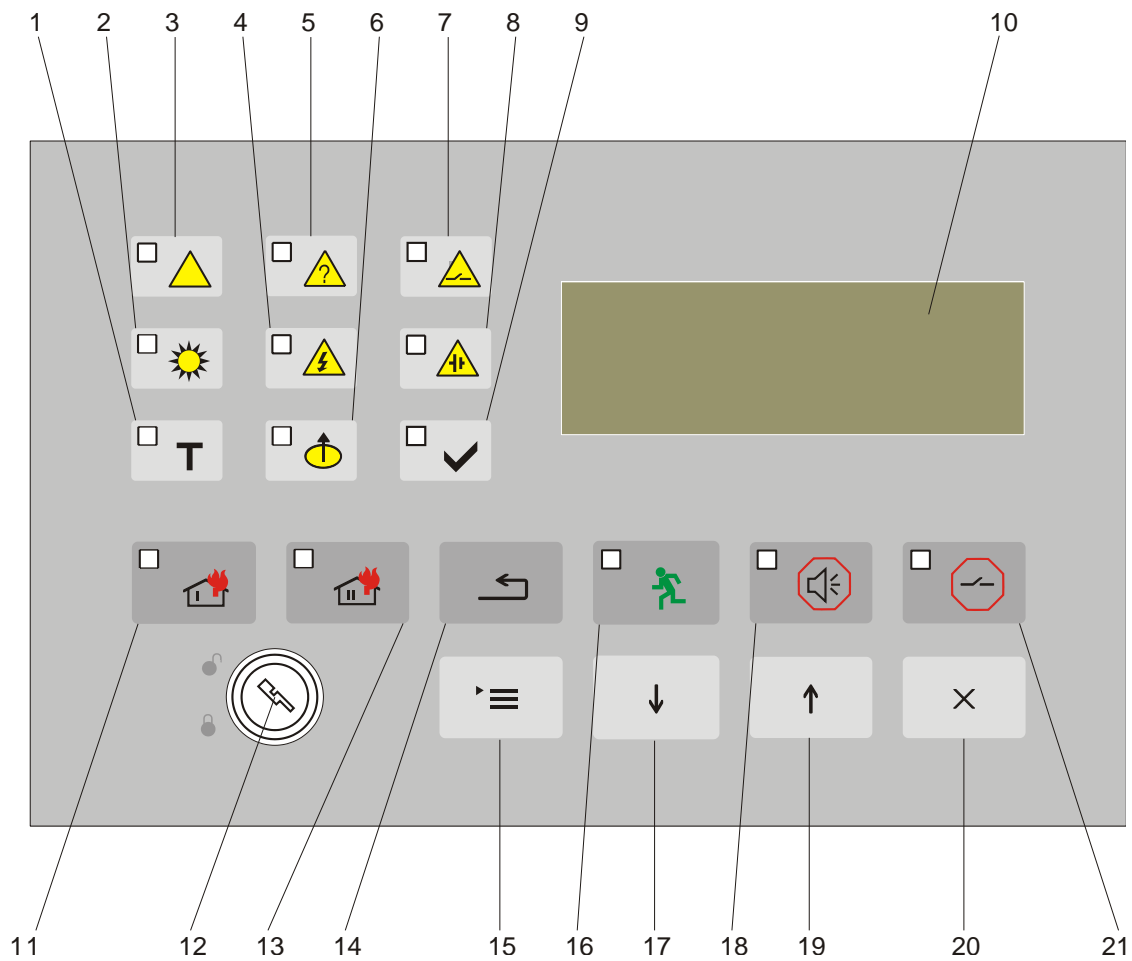

- 1 Indicator *Test*
- 2 Indicator *Day Mode*
- 3 Indicator *System fault*
- 4 Indicator *Fault in mains power supply*
- 5 Common indicator for fault condition
- 6 Indicator *Disabled component*
- 7 Indicator *Out of order/disabled controllable output*
- 8 Indicator *Fault in backup batteries*
- 9 Indicator *Power supply*
- 10 LCD display (4x20)
- 11 Common indicator Fire condition stage I
- 12 Key for Access level 2
- 13 Common indicator Fire condition stage II
- 14 Button *Reset Line*
- 15 Buttons *Menu*
- 16 Button with indicator *Inspection*
- 17 Button *Down*
- 18 Button *Alarm* with indicator *Stop Alarm*
- 19 Button *Up*
- 20 Button *Cancel*
- 21 Button *Outputs* with indicator *Suppressed outputs*

Front panel of FS5200

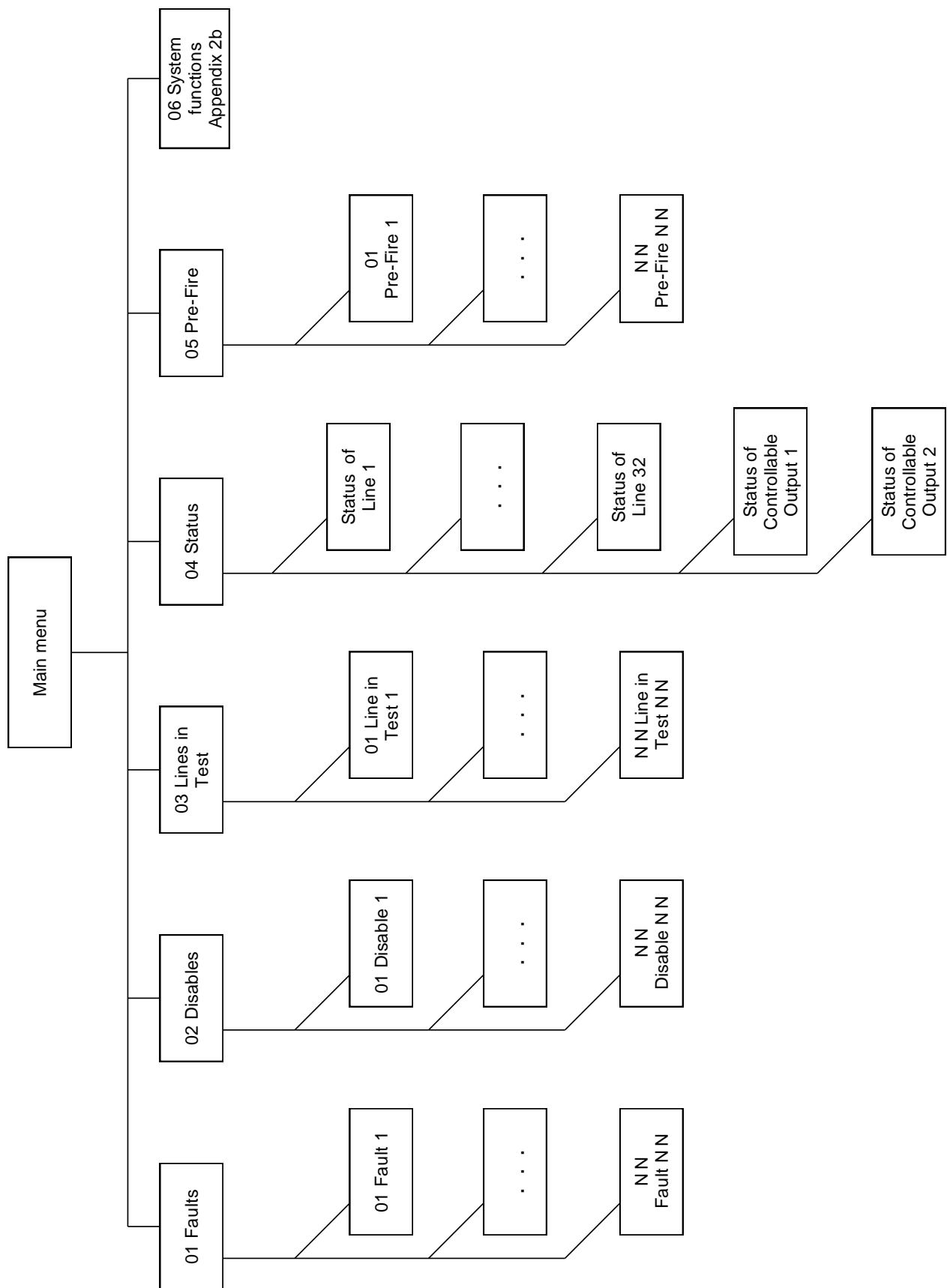

a) Basic menu

Appendix 2 - continued

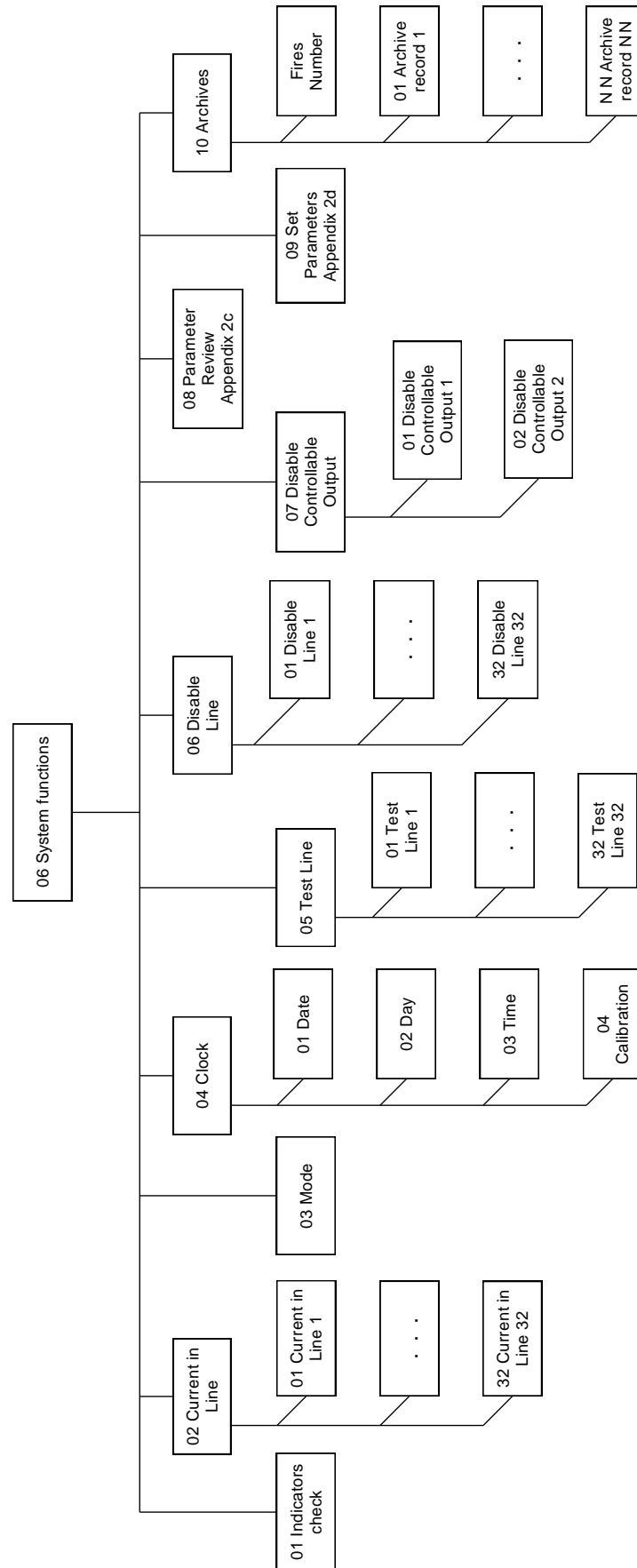

b) Menu System functions

Appendix 2 - continued

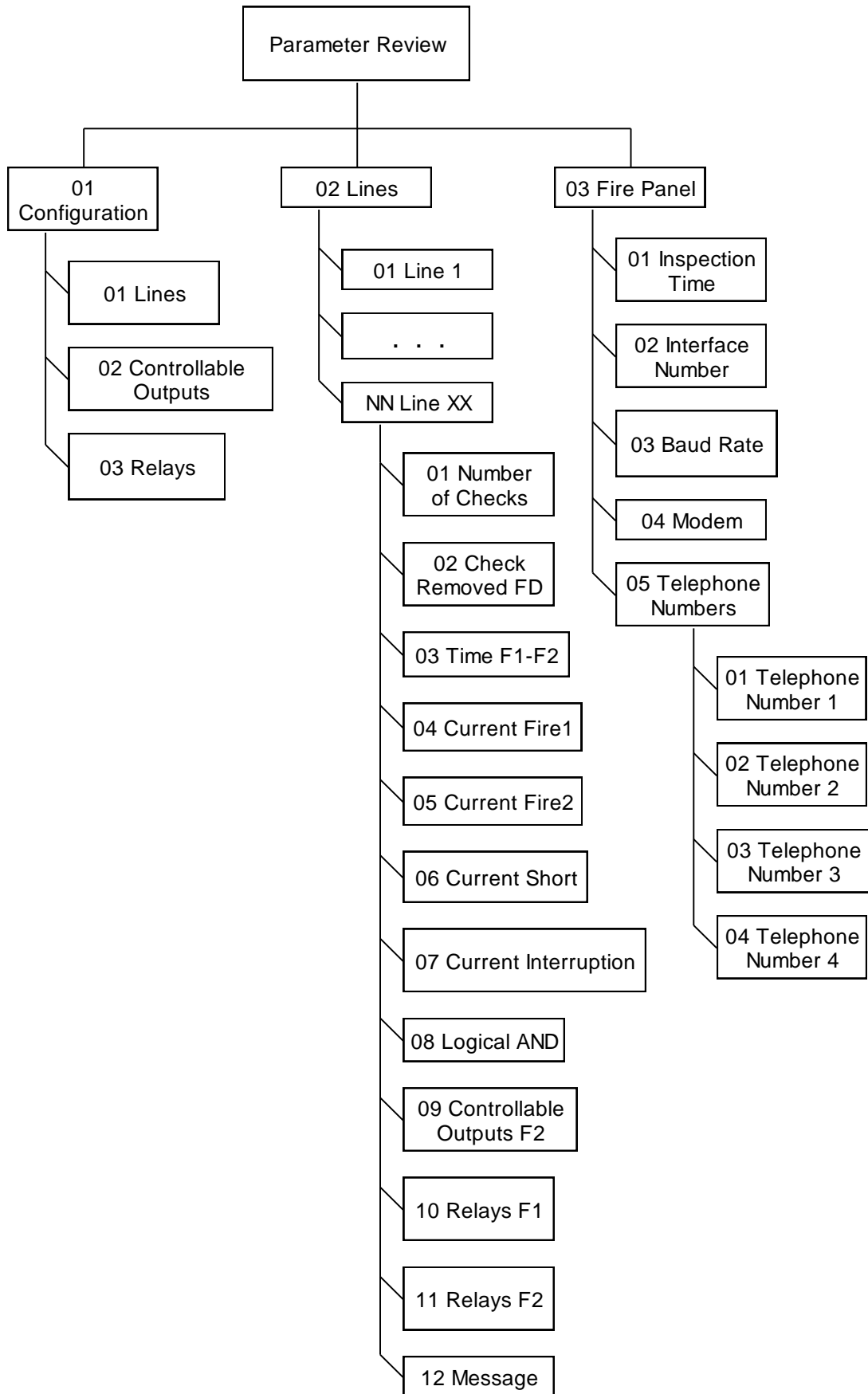

c) Menu *Parameter check*

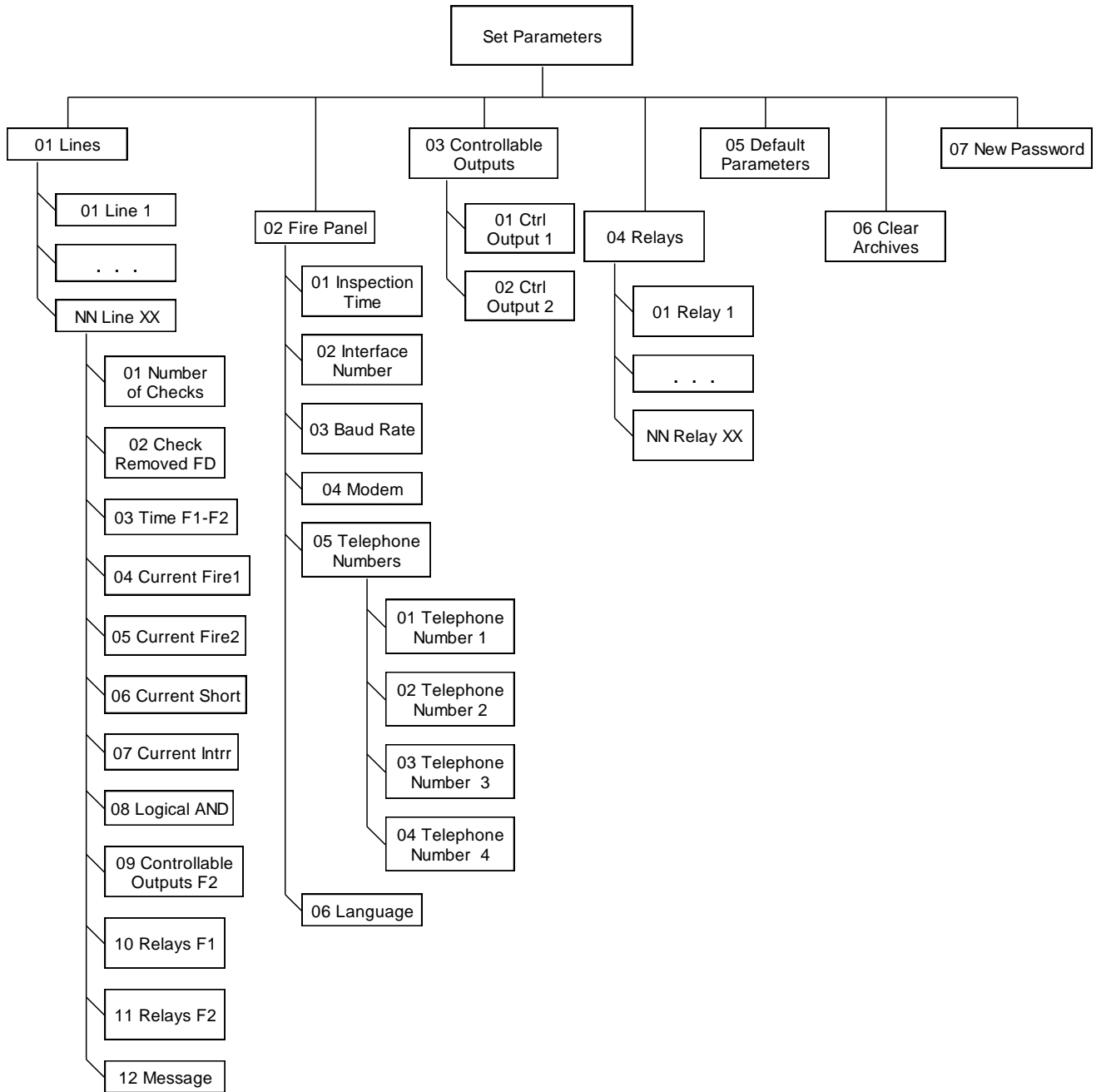

d) Menu SetUp

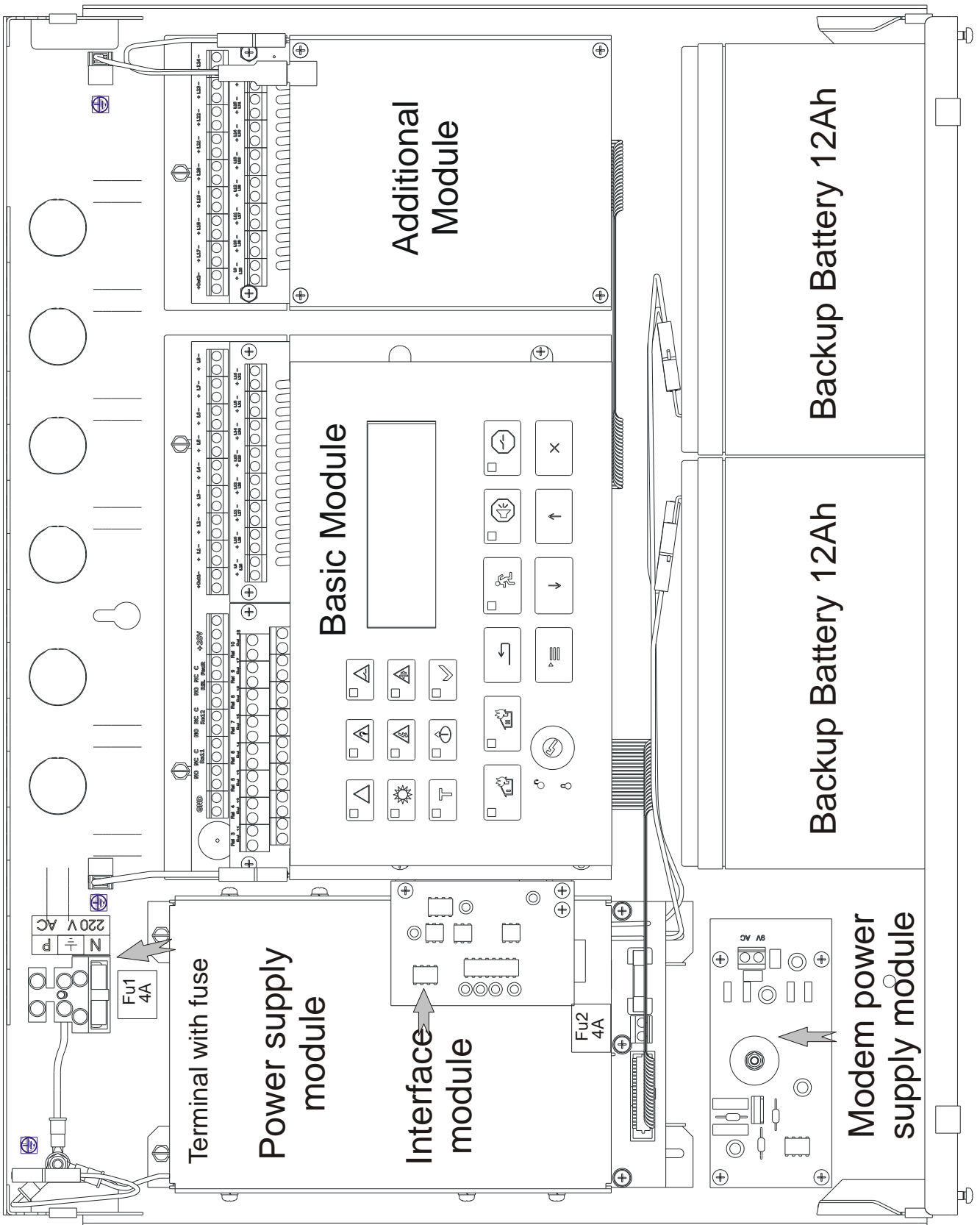

Assembly diagram

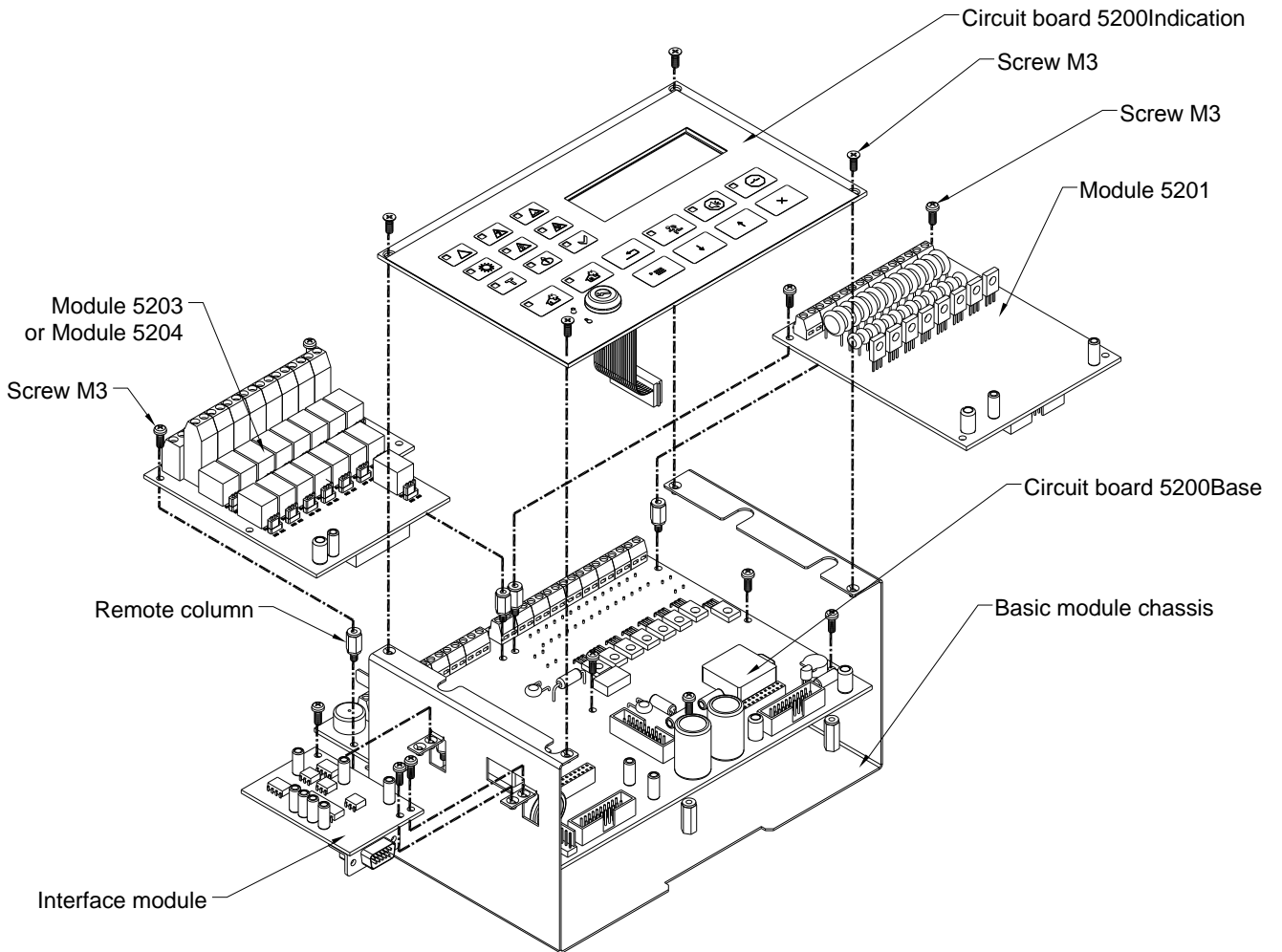

a) Basic Module - layout

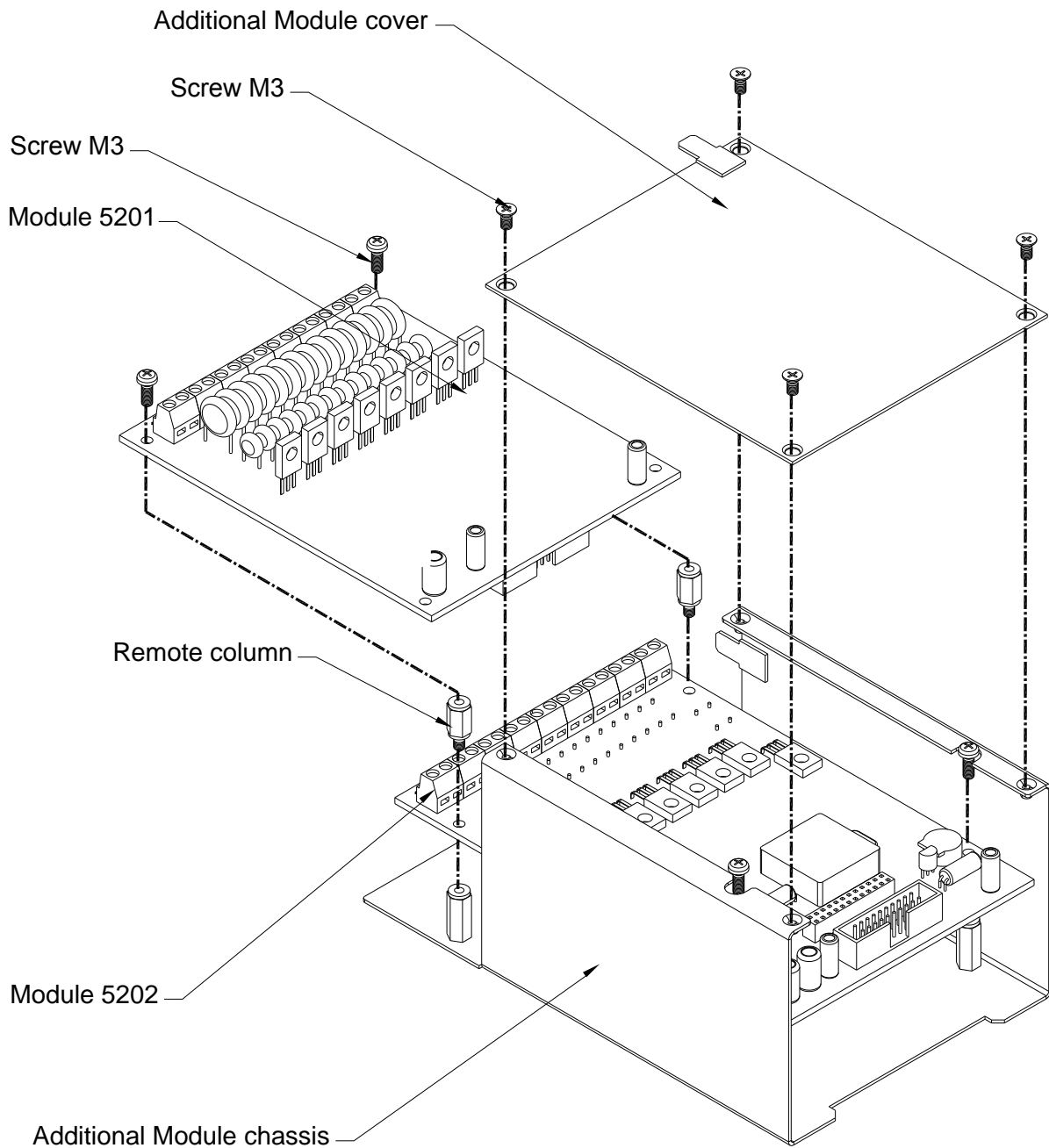

b) Additional Module – layout

Appendix 4 - continued

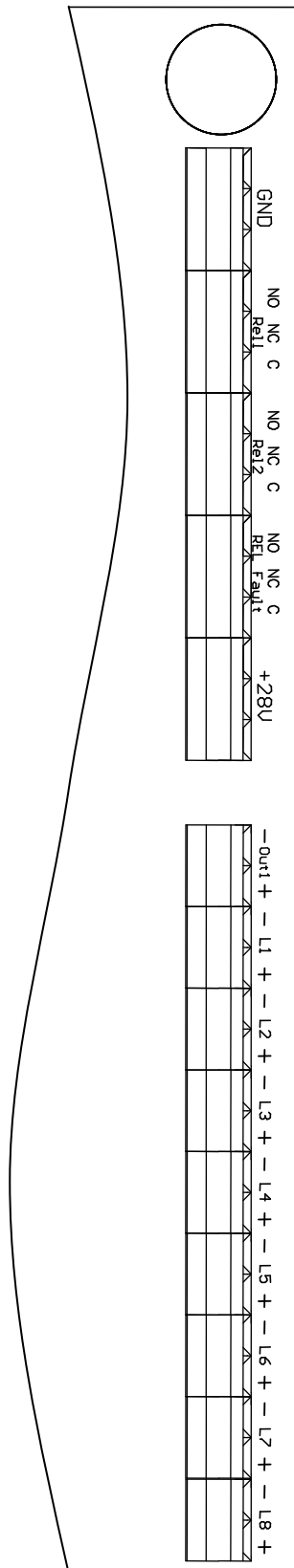

GND – negative lead of power supply to external devices (chassis earth);

Rel X – relay output for fire condition № X, where X is from 1 to 2

C – common contact

NO – normally open contact

NC – normally closed contact

Rel Fault – relay output for fault condition

C – common contact

NO – normally open contact

NC – normally closed contact

+28V – positive lead of power supply to external devices

Out 1 – leads of Controllable output 1

“+” – positive lead

“-” – negative lead

L X – leads of fire alarm line № X, where X is from 1 to 8

“+” – positive lead

“-” – negative lead

c) Circuit board 5200Base (Basic Module) – terminals

Appendix 4 - continued

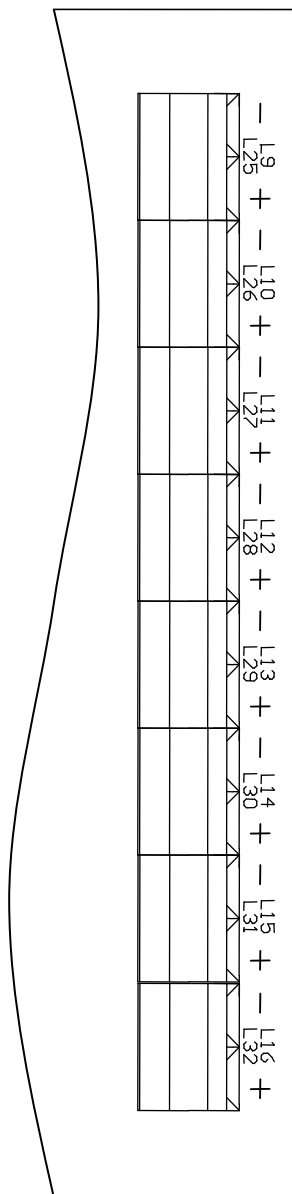

L X – leads of fire alarm line № X, where X is:
 = from 9 to 16 when Module 5101 is in Basic Module
 = from 25 to 32 when Module 5101 is in Additional Module

“+” – positive lead
 “-” – negative lead

d) Module 5201 (Basic Module or Additional Module) – terminals

Appendix 4 - continued

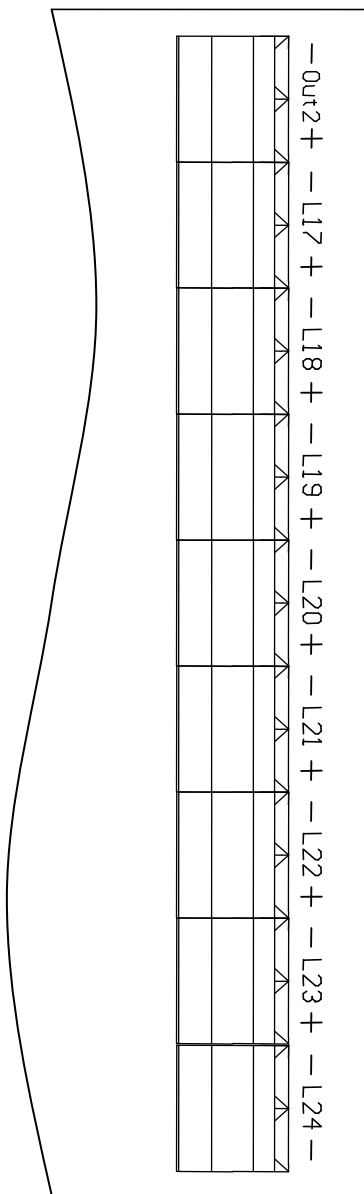

Out 2 – leads of Controllable output 2
 „+” – positive lead
 „-” – negative lead

L X – leads of fire alarm line № X,
 where X is from 17 to 24
 “+” – positive lead
 “-” – negative lead

e) Module 5202 (Additional Module) – terminals

Appendix 4 - continued

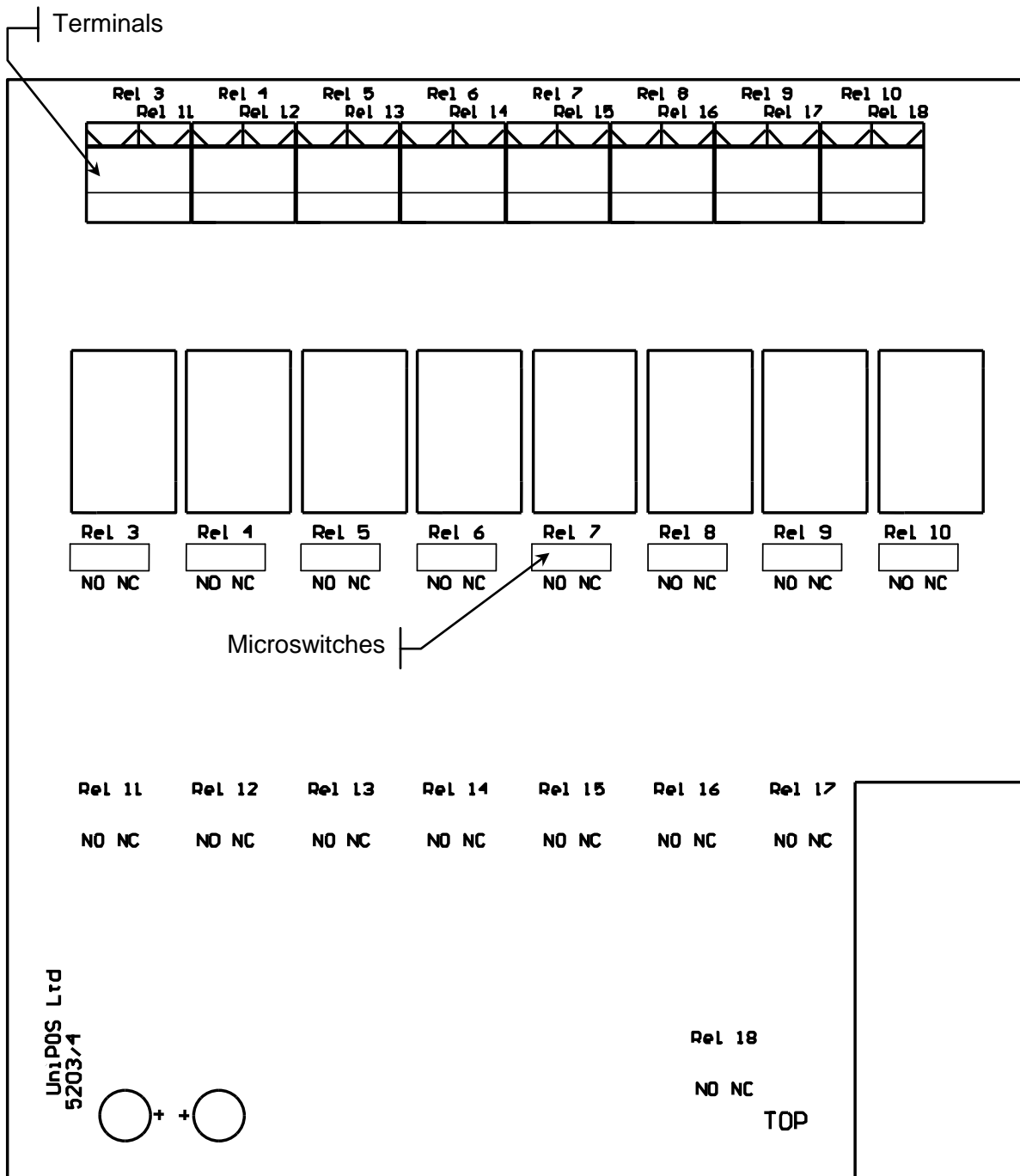

Terminals:

Rel X – relay output for fire condition № X, where X is from 3 to 10

Microswitches for selection of contact type:

Rel X – relay output for fire condition № X where X is from 3 to 10

NO – normally open contact

NC – normally closed contact

f) Module 5203 (Basic Module) – terminals

Appendix 4 - continued

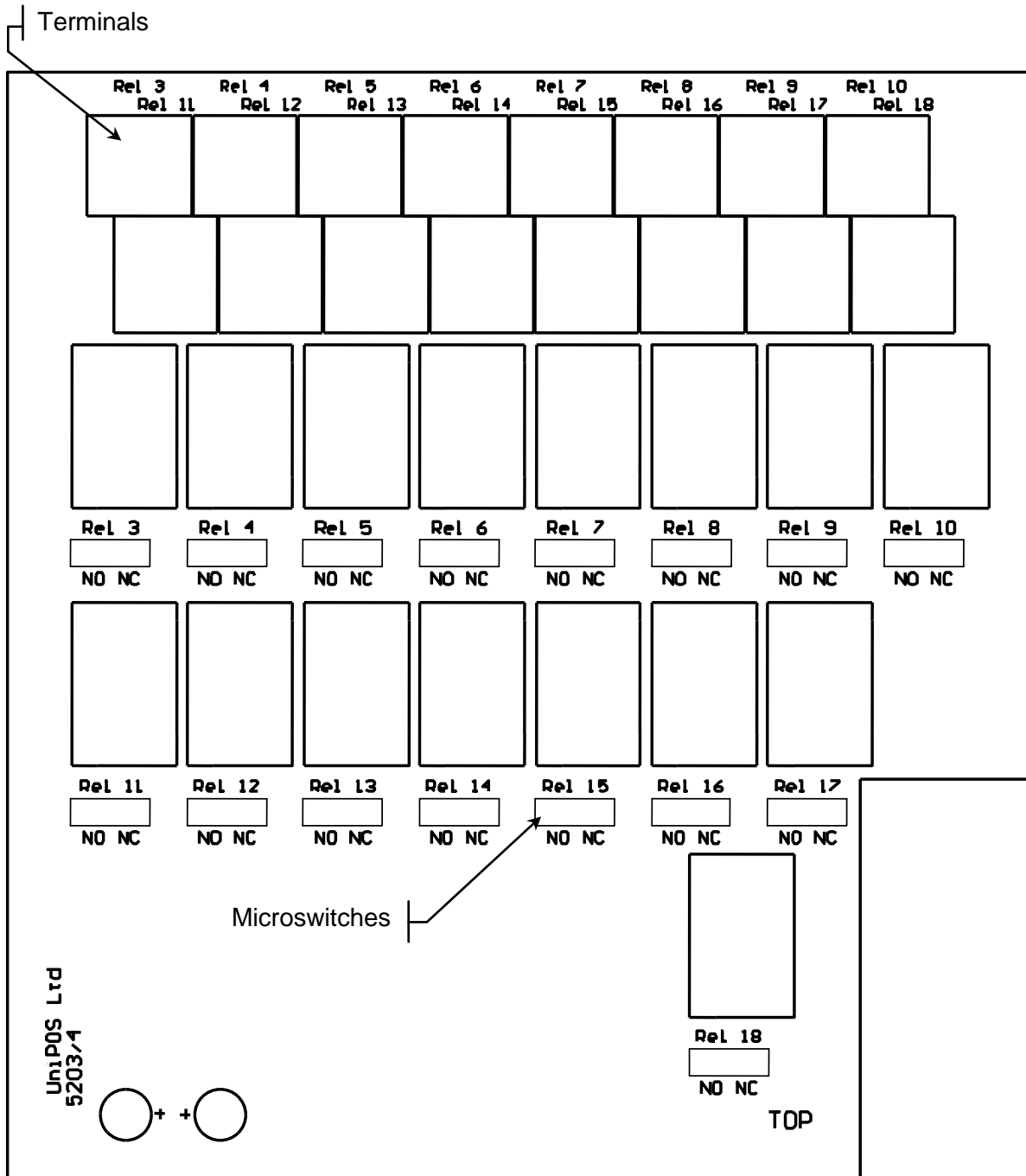

Terminals:

Rel X – relay output for fire condition No X, where X is from 3 to 18

Microswitches for selection of contact type:

Rel X – relay output for fire condition No X where X is from 3 to 18

NO – normally open contact

NC – normally closed contact

g) Module 5204 (Basic Module) – terminals

Appendix 5

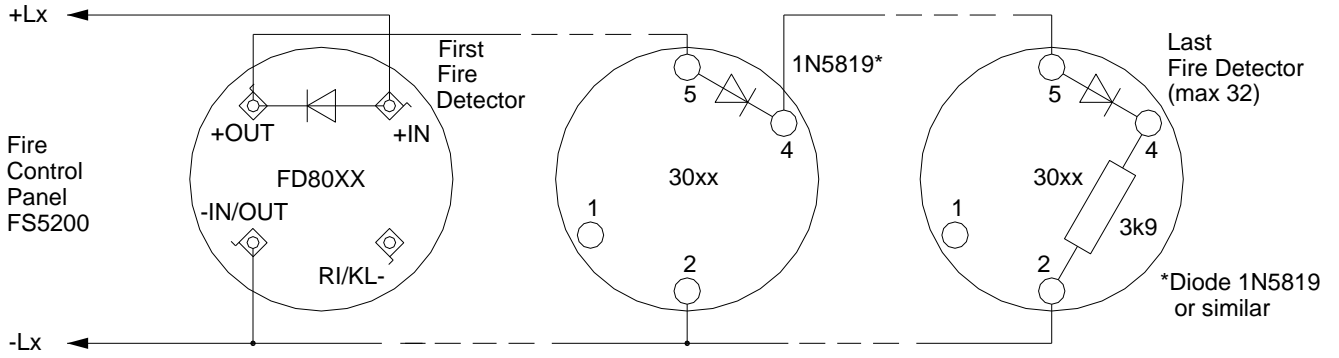

a) Fire alarm line with automatic fire detectors type FD3000 or FD8000

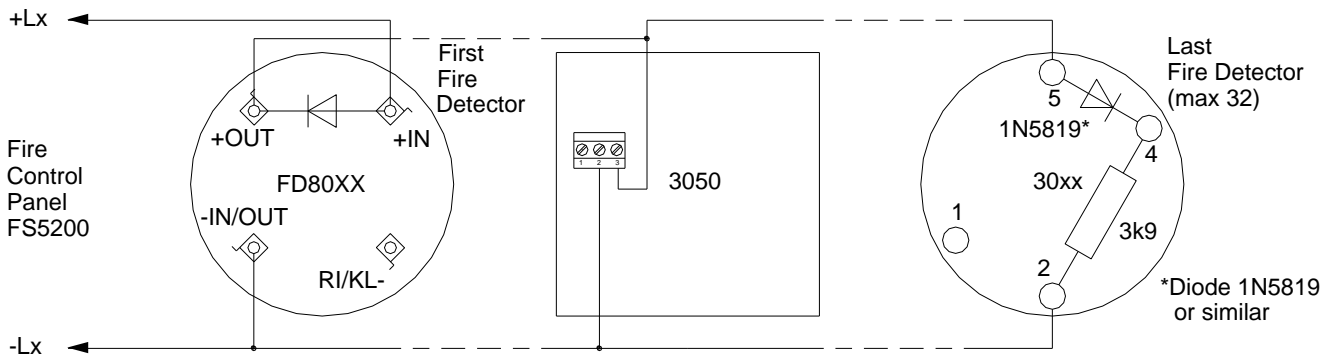

b) Fire alarm line with group addressing of automatic fire detectors type FD3000 or FD8000 and manual call points type FD3050

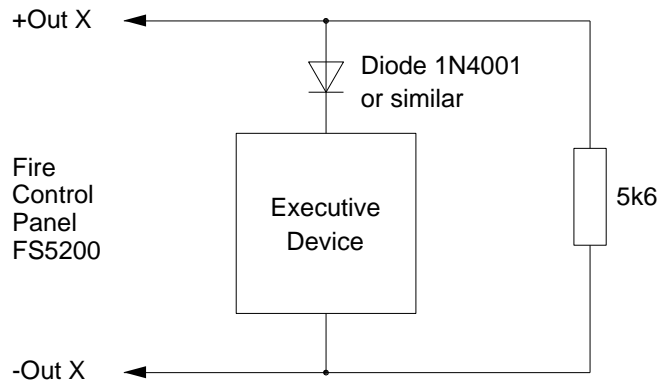

c) Connection of executive device to a controllable output

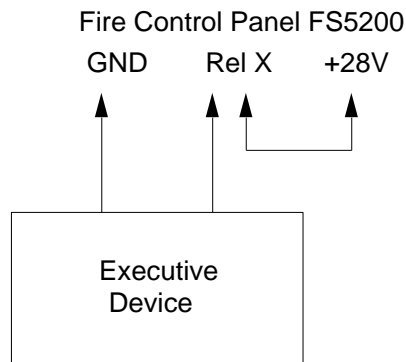

d) Connection of executive device to a relay output

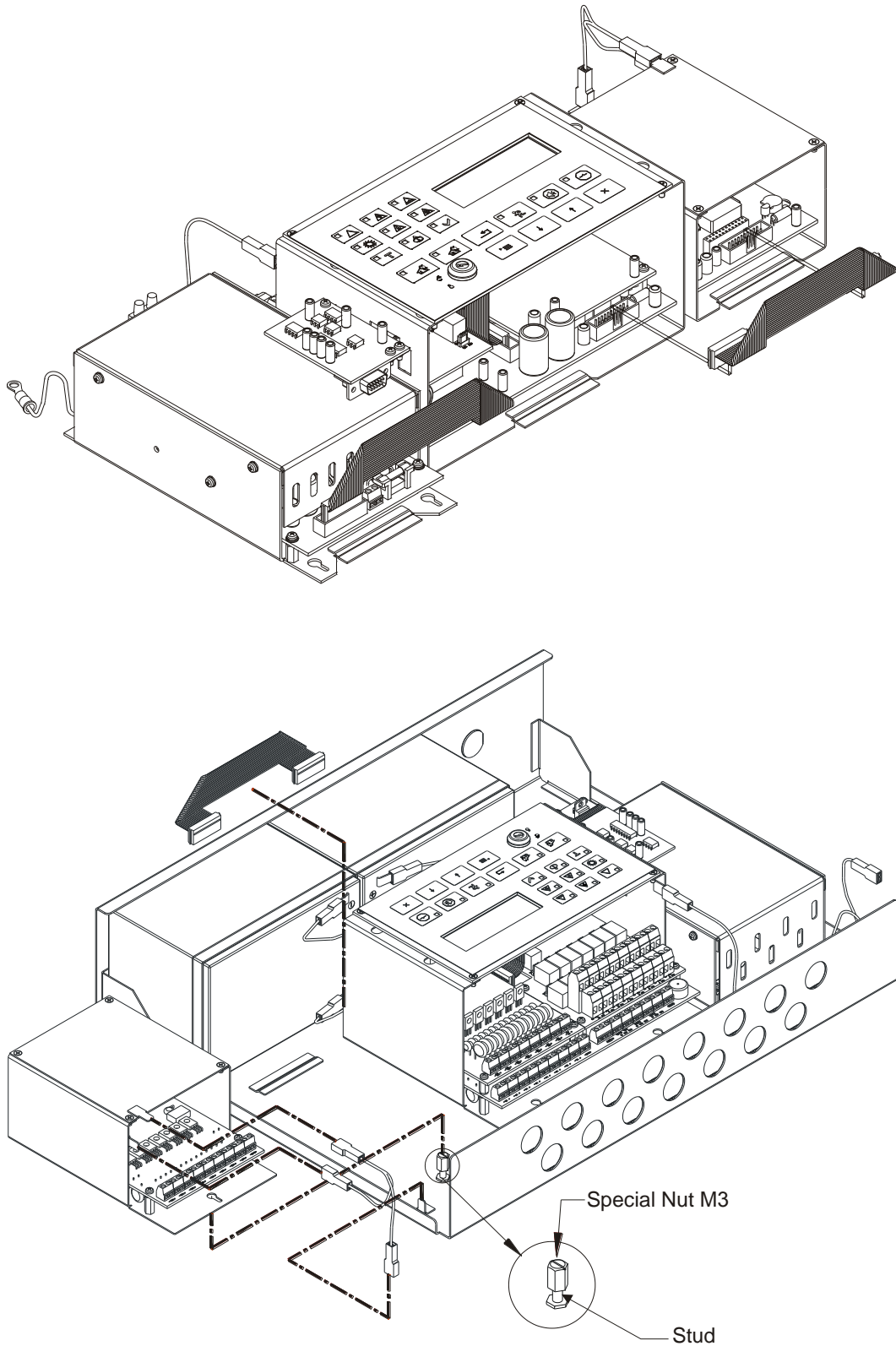

Connection diagram for Additional Module

Appendix 7

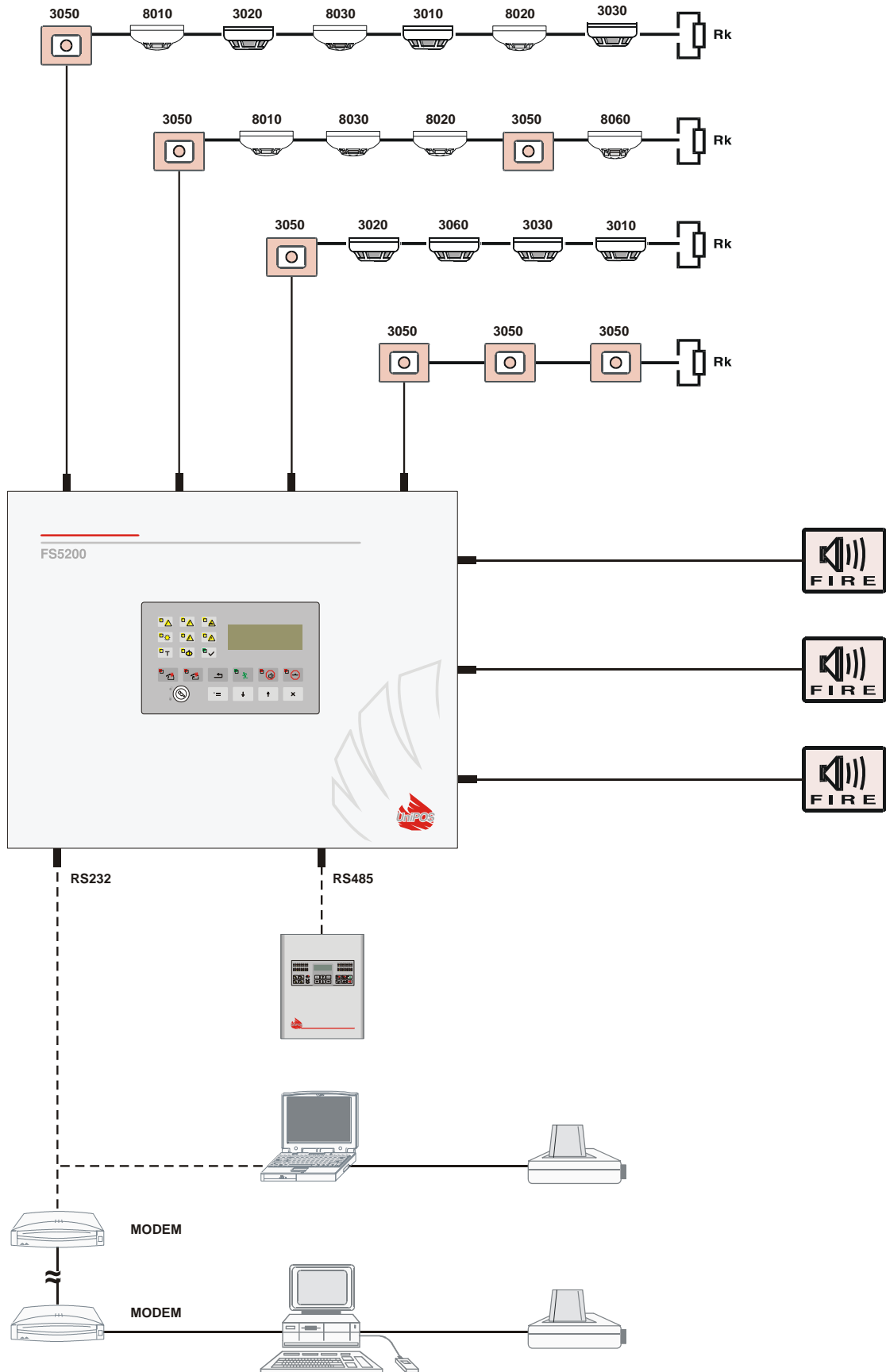

Diagram of fire alarm installation based on Fire control panel FS5200