

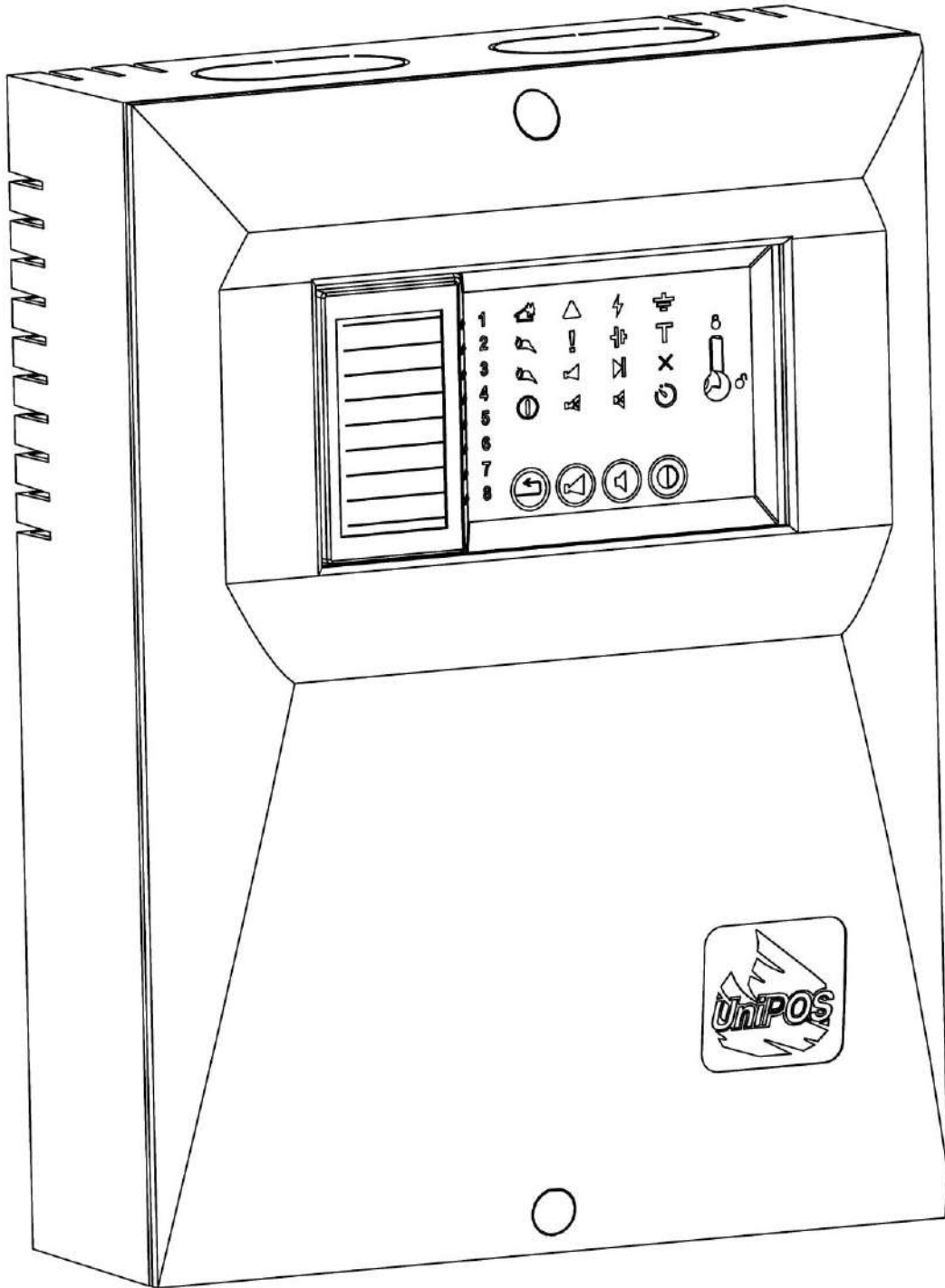

Fire Control Panel FS4000



INSTRUCTION MANUAL

Revision 11/01.17

Contents

1. Introduction	3
2. Terminology	3
3. Function	4
4. Technical features	4
4.1 Fire alarm lines	4
4.2. Current thresholds for	4
4.3. Monitored output for fire condition	4
4.4. Relay output for fault condition	5
4.5. Input for remote Reset fires.....	5
4.6. Performance	5
4.7. Indications of registered events	5
4.8. Power supply	6
4.9. Power supply to external devices	6
4.10. Fuses.....	6
4.11. Dimensions	6
4.12. Weight, backup batteries not included	6
5. Contents of delivery	6
6. General information	7
6.1 Access levels	7
6.2. Indications and control	7
6.3. Duty mode configurations - General information	9
6.4. Conditions of the fire control panel	10
7. Duty mode	10
7.1. Description	10
7.2. LED and sound indication	10
7.3. Using the buttons	11
7.4. Additional options	11
8. Fire condition	11
8.1. Description	11
8.2. Led and sound indication	11
8.3. Using the buttons	12
9. Fault condition	12
9.1. Description	12
9.2. Led and sound indication	13
9.3. Using the buttons	13
10. Disabled component mode	14
10.1. Description	14
10.2. Disable/Enable a line	14
10.3. Disable/Enable outputs in Fire condition	15
10.4. Switching ON/OFF Communicaton interface RS485	16
10.5. Enable/Disable “EARTH detection”.....	16
10.6. Enable/Disable “Check Rem.Det”.....	16
11. Test condition	17
11.1. Description	17
11.2. Setting/Removing a line in Test condition	17
12. Delay of outputs	18
12.1. Description.....	18
13. User configuration of outputs	18
14. Installation and initial start of the fire control panel	19
14.1. To mount the fire control panel	19
14.2. Periphery devices assembly	30
14.3. Connecting Remote Reset Input / “Activate monitored outputs”.....	31
14.4. Connecting fire detectors	31
14.5. Connection to power supply	31
15. Fire control panel start up	32
16. Conditions of operation, storage and transportation	32
17. Warranty	32
18. Appendixes	33

1. Introduction

Fire control panel FS4000 is an up-to-date, highly reliable, multifunctional and versatile unit. It is designed to receive signals from manual call points and automatic fire detectors, releasing sound and light indication. The fire control panel provides options for connection of external signal and executive units.

2. Terminology

DELAY OF OUTPUTS – delay of activation of monitored and relay outputs with a certain period of time from the moment a fire condition is registered. Typically, the delay period is sufficient for the staff to inspect the premises indicated by the fire control panel. The delay is eliminated through activation of a manual call point (response current $\geq 44\text{mA}$ at 24V) or by a fire condition in another line. The delay time is user programmable and is equal for all fire alarm lines.

DISABLED LINE – a switched off *line*, without power supply, not controlled for activated fire detectors and fault condition. This condition is user defined. The indication for a disabled line includes common light indication and separate light indication for each line.

DISABLED OUTPUTS – *the monitored output* and *the relay output* are switched off (executing devices can not be activated) and are not monitored for a fault condition. This feature is user defined. The indication for a disabled monitored output includes common light indication and separate light indication for the monitored output.

EARTH fault – non-system *non-fatal fault condition*, due to leakage to a earthed wire.

MONITORED OUTPUT – potential output that monitors the serviceability of the connection wires between the fire control panel and the executing device.

SHORT CIRCUIT IN A LINE OR IN A MONITORED OUTPUT – non-system *non-fatal fault condition* due to registered current value in a *line* or in a *monitored output* that exceeds a specified threshold value.

LINE IN TEST – a *line* set by the user to Test condition. The line is powered and reset (the power is cut off for 3 s) periodically every 64 s. The events registered in a line in Test condition are not saved in the archive and do not trigger associated outputs nor light and sound signalling. The indication for a line in Test condition is common light indication and separate light indication for each line.

LOCAL SOUNDER - buzzer built-in the fire control panel

NON-FATAL FAULT CONDITION – fault condition that allows the fire control panel to continue operation. A non-fatal fault condition is usually a *non-system* fault condition. The indication is common light indication, local sound indication and text messages on the LCD display.

ACCESS LEVEL – access level to various indications and control functions.

LOW BATTERY – non-system *fatal fault condition* due to full discharge of the backup batteries upon interrupted power supply.

SUPRESSED OUTPUT – *monitored* or *relay* output which should normally be activated upon Fire condition, but is manually switched off by the user.

FIRE ALARM LINE (further on it will be referred as *LINE*) – a combination of automatic fire detectors and manual call points, physically connected by the means of two-wire connection. The basic configuration of FS 4000 includes 2 lines; the maximum configuration includes 8 lines. Up to 32 fire detectors can be integrated into one line.

FIRE CONDITION – Fire condition phase entered by the control panel upon activation of automatic fire detector or manual call point. Common light indication and separate light indication for each line, local light indicators and local sound signaling indicate the phase.

FIRE CONDITION 1st STAGE – Fire condition phase, is when the Control Panel indicates activation of automatic fire detector or manual call point. This phase continues until estimated time. Indication includes light indication and local sound signaling.

FIRE CONDITION 2nd STAGE – Fire condition phase, entered by the Control Panel indicates that the estimated time of fire condition phase first stage has expired or upon manual call point activation. Indication includes light indication and local sound signaling.

INTERRUPTED LINE OR MONITORED OUTPUT – non-system *non-fatal fault condition* due to current value in a *line* or in a *monitored output* lower than the threshold value.

RELAY OUTPUT – relay, potential-free, switching outputs that control external executive devices.

SYSTEM FAULT – fault condition due to a fault in a basic component of the fire control panel (or the system). The System fault may be a *fatal error* or a *non-fatal error*. The event is indicated by common light indicators and local sound signaling.

REMOVED FIRE DETECTOR – non-system *non-fatal fault condition* due to removed fire detector in a *line*.

FUNCTION "LOGICAL AND " OF TWO LINES - function that enables the fire Control panel to indicate FIRE CONDITION FIRST STAGE when automatic detectors are activated at the same time in two lines.

3. Function

Fire control panel FS4000 is designed to operate with conventional automatic fire detectors and manual call points. The panel has outputs provided for external executive devices.

The unit is produced in four versions:

- | | |
|----------------------|------------|
| ◆ 2 fire alarm lines | - FS4000/2 |
| ◆ 4 fire alarm lines | - FS4000/4 |
| ◆ 6 fire alarm lines | - FS4000/6 |
| ◆ 8 fire alarm lines | - FS4000/8 |

4. Technical features

4.1. Fire alarm lines:

- | | |
|--|------------|
| – Maximum number of fire detectors in a line | - 32 |
| – Connecting line | - two-wire |
| – Maximum resistance of a line | - 100Ω |

4.2. Current thresholds for:

- | | |
|-----------|-------------------|
| ◆ 0÷6mA | - Fault condition |
| ◆ 6÷16mA | - Duty mode |
| ◆ 16÷80mA | - Fire condition |
| ◆ >80mA | - Short circuit |

4.3. Monitored outputs for fire condition:

- | | |
|------------------------------|---|
| -- Number | - 2 pcs |
| – Type | - potential, relay with independent control |
| – Electrical characteristics | - (19÷27.5)V/1A |

4.4. Relay outputs:

4.4.1. Relay outputs for fire condition

Number	- 2
Type	- potential-free, 1 switching , 1 NO with independent control
Electrical characteristics	- 3A/125V AC, 3A/30V DC

4.4.2. Relay output for fault condition

Number	- 1
Type	- potential-free, switching
Electrical characteristics	- 3A/125V AC, 3A/30V DC

4.5. Input for remote “Reset fires” or “Activate monitored outputs” (refer p.6.3):

Reset fire Input for remote Reset fires operation.

Number	- 1
Type	- none-monitored type activated on short-circuit (from potential-free contact)
Electrical characteristics	- 5 Vdc on normal open state - 0 Vdc in activation mode

4.6. Performance:

- Control over fire alarm lines and monitored outputs for fault conditions (short circuit and interruption) and automatic reset
- Detection of removed fire detector and automatic reset;
- Identification of manual call points;
- LED indication for alarm state and emergency;
- Delay of outputs for fire condition with time period of 1, 2, 3, 4, 5, 6 or 7 minutes after fire condition is registered;
- Option for " LOGICAL AND " realization of two fire alarm lines;
- Duty Mode condition with direct activation of Fire Condition 2nd Stage " for two fire alarm lines.
- Status Indication of the device for data transmission RS485;
- Option for switching on/off interface RS485 communication
- Built-in buzzer for fire condition – one tonal, continuous, can be switched off;
- Built-in buzzer for fault condition – one tonal, discontinuous, can be switched off;
- Test mode for fire alarm lines;
- Disabling fire alarm lines;
- Disabling outputs for fire condition.
- Expanding the options by means of extra relay outputs for fire condition for each line and built-in RS485 for operation in a local network.
- Input for remote Reset fires operation or remote activation of the monitored outputs for Fire Alarm Devices (refer p.6.3);
- 8 pcs. UniPOS Automatic Fire Detectors (or 4 pcs. With connected RI31 remote indicators) simultaneously in Fire per zone, before the Short-circuit protection of the line is triggered. It is because of the self-adaptive current thresholds per zone.

4.7. Indications of registered events:

- Light indication - LED
- Sound - built-in buzzer

4.8. Power supply

4.8.1. Mains:

- voltage - (100÷240)V
- frequency - 50/60Hz

4.8.2. Backup batteries:

- battery type - lead, gel electrolyte
- number of batteries - 2 pcs
- nominal voltage of the backup battery - 2x12VDC
- nominal capacity C_{20} - (7,0) Ah
- charge voltage - 27,5 VDC

Operation in Duty mode upon interruption in main power supply

	24V/ 7,0Ah	24V/ 4.5Ah	24V/ 1.2Ah
Configuration 2 lines	180h	120h	32h
Configuration 4 lines	140h	98h	24h
Configuration 6 lines	110h	80h	20h
Configuration 8 lines	90h	68h	16h

4.8.3. Consumption on backup batteries supply:

- Configuration of 2 lines - < 35mA at 24V
- Configuration of 4 lines - < 45mA at 24V
- Configuration of 6 lines - < 55mA at 24V
- Configuration of 8 lines - < 65mA at 24V

4.9. Power supply to external devices:

- voltage - (19÷27)V
- maximum current value (including current of monitored outputs) - 1,2A

4.10. Fuses:

- Main supply 230V - 4.0A
- Backup battery - 6,0A
- Power supply to external devices - 1,85 A automatic
- Monitored outputs - 1,1 A automatic

4.11. Dimensions

- 304x222x94 mm

4.12. Weight, backup batteries not included

- 0,98kg

5. Contents of delivery:

- Fire control panel FS4000 - 1 pc
- End of line resistors 3,0k / 0.6W
 - ◆ for 2 lines - 2 pcs
 - ◆ for 4 lines - 4 pcs
 - ◆ for 6 lines - 6 pcs
 - ◆ for 8 lines - 8 pcs
- Resistor 5,6kΩ / 0,25W - 2 pcs
- Fuse 6,0A - 1 pc
- Fuse 4,0A - 1 pc
- Cable bridge - 1 pc
- Brochure - 2 pc
- Screws to fix the front cover - 2 pcs.
- Packing - 1 pc

6. General information

6.1. Access levels

There are 4 levels of access to the variable indications and control functions of FS4000

6.1.1. Access level 1

All persons who would presumably find out and react to alarm for fault condition or fire condition have access to level 1. All light indicators are visible here.

6.1.2. Access level 2

For the personnel in charge for the fire protection; they shall be trained and authorized to operate the fire control panel in the following conditions:

- Duty Mode;
- Fire condition;
- Fault condition;
- Disabled component;
- Test.

To enter Access level 2  place the key in open condition

The following features are accessible:

- exit of fire condition (see pp.12-13);
- suppressing the outputs activated upon fire condition;
- suppressing the local buzzer;
- forced proceeding of the monitored outputs;
- connection of fire alarm lines and executive devices;

6.1.3. Access level 3

To enter Access level 3 open the front cover of the control panel and .place the key to open condition .

The following features are accessible:

- all options from Access level 1 and 2;
- replacing a burnt fuse;
- setting the overdue outputs
- disabling a line;
- disabling outputs for fire condition;
- Setting a line in test mode;
- Setting a line in Duty mode with direct Fire condition 2nd stage activation;
- Switching on / off communication interface RS485;
- Choosing user configuration for the outputs;
- Module FD4201 assemblage;
- Toggle the mode of the “RST” input application;

6.1.4. Access level 4

Accessible for personnel trained and authorized by the Producer to repair the fire control panel and to modify the software. Special means are required for access to this level.

6.2. Indications and control

Table 1 gives detailed description of the indications for each status, table 2 presents the basic means for control. In Appendix 1 is displayed the front panel of the control panel with indications and control.

Table 1

Conditions of the fire control panel	Indication
All conditions - The fire control panel is power supplied	 Indicator <i>Power supply</i> – continuous green light



















Conditions of the fire control panel	Indication									
All conditions		Indicator <i>Delay of outputs</i> - continuous yellow light								
Fire condition		Common indicator <i>Fire condition</i> – flashing light or flashing red light								
Fire condition and Fault condition - Sound signaling is suppressed		Indicator <i>Stop/Start Buzzer</i> - continuous red light								
Fire condition- Outputs for fire condition are disabled		Indicator <i>Stop/Start Outputs</i> - continuous red light								
Fault condition - all types of faults		Common indicator <i>FAULT condition</i> - flashing yellow light								
Fault condition – System fault		Indicator <i>System fault</i> – continuous yellow light								
Fault condition - Fault in mains supply		Indicator <i>Fault in mains supply</i> - continuous yellow light								
Fault condition - Fault in the backup batteries or in the charger		Indicator <i>Backup battery fault</i> - continuous yellow light								
Fault condition- Fault in internal power supply units, voltage for supply of lines and/or user voltage 24V		Indicator Fault in internal power supply unit - continuous yellow light								
Fault condition - Fault in a monitored output		Indicator <i>FAULT in/Disabled monitored output</i> – flashing yellow light								
Fault condition – Earth FAULT Leakage to earthed wire or earthed case		Indicator Earth FAULT – continuous yellow light								
Disabled component - Disabled line or monitored output		Indicator <i>Disabled component</i> - continuous yellow light								
Test condition		Indicator Test - continuous yellow light								
Condition of the device for RS485 interface communication		Indicator for the Condition of the device for RS485 communication - red LED for a signal confirmation from Remote Control Panel FS5200R; - yellow LED Indicates Fault Condition in the network or in the transmitting device.								
Fire condition / Fault condition	<table border="1"> <tr><td>1</td></tr> <tr><td>2</td></tr> <tr><td>3</td></tr> <tr><td>4</td></tr> <tr><td>5</td></tr> <tr><td>6</td></tr> <tr><td>7</td></tr> <tr><td>8</td></tr> </table>	1	2	3	4	5	6	7	8	Individual indicators for Fire condition and Fault Condition in line “N”- - red light and continuous signal from the local buzzer in Fire condition; - yellow flashing light and interrupted signal from the local buzzer in Fault condition;
1										
2										
3										
4										
5										
6										
7										
8										

Table 2

Means of control	Condition of the fire control panel	Access level	Operation
Button <i>Reset</i> 	Fire condition	Level 2	Exit of Fire condition
Button <i>Outputs</i> 	Fire condition	Level 2	- if outputs for fire condition are activated – to suppress the outputs; - if outputs for fire condition are not activated – to force activation
Button <i>Buzzer</i> 	Fire condition and Fault condition	All Levels	To suppress / activate the local buzzer
Button <i>Test Indication</i> 	Duty mode	All Levels	LED indication and Testing of the sound signal

Remote Input “RST” for remote reset fire operation. On short-circuit activation on the input then the zones in fire will be reset and the panel exit from fire.

6.3. Configuration modes of lines, outputs and operation of the interface RS485 – General description

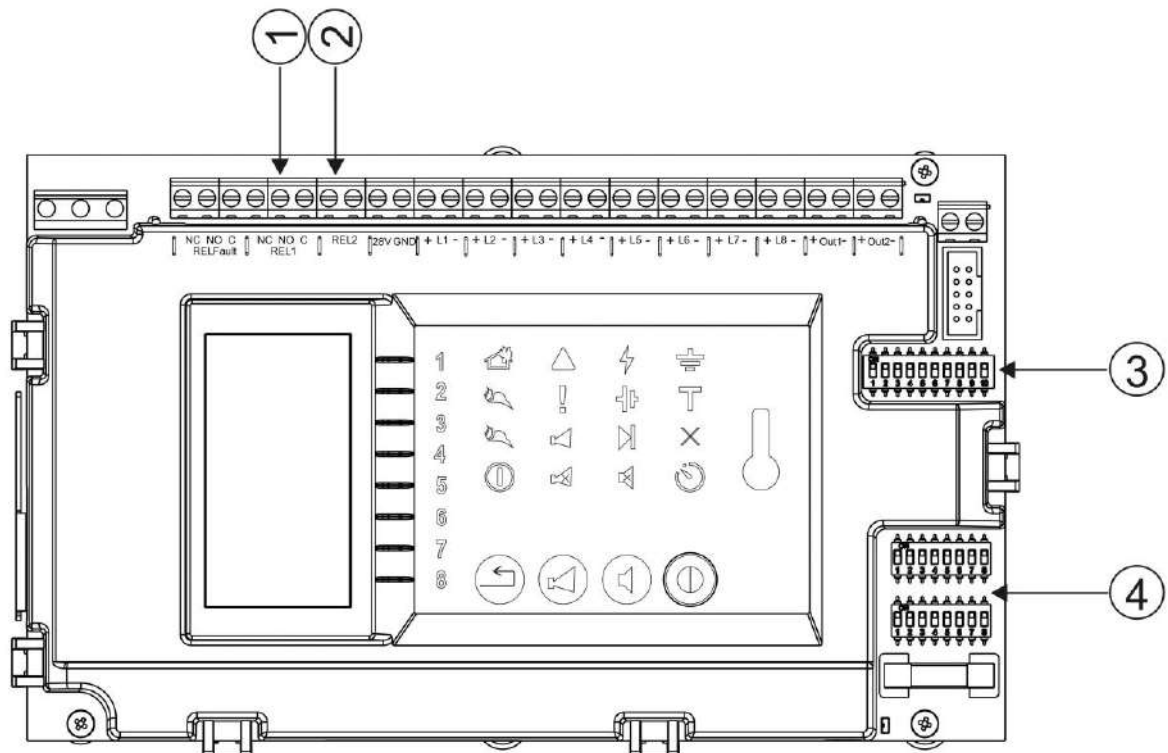



Fig. 1

In the Fire Control Panel through DIP-switches there are options for:

- defining operation mode of the lines (pos.4, fig.1);
- defining time delay (pos.3, fig. 1);
- disabling monitored outputs (pos.3, fig. 1);

- switching on/off communication interface RS485 (pos.3, fig .1);
- configuring of outputs with 8 steady set user combinations (pos.3, fig .1)
- disabling “Earth FAULT” (pos.3, fig. 1);
- disabling “Check Rem. Det. (pos.3, fig. 1).

The application mode of the “RST” input can be toggled from “Reset fires” to “Activate monitored outputs” and vice-versa through the following simultaneous combination:

- To enter Access level 2  place the key in open condition;
- Hold the control button “Reset”;
- Power-up the panel (from the Accumulator batteries or the Mains 220 Vac);

If the described above combination is true simultaneously, then the application mode of the input “RST” and relay fire output “REL2” is toggled through the following modes:

- Mode 1 – on trigger on the “RST” input are activated monitored outputs “Out 1” and “Out 2”. The fire relay output “REL 2” is suppressed in Fire Alarm mode from control button “Outputs”;
- Mode 2 – on trigger on the “RST” input are reset the fire events in the Fire Control Panel. The fire relay output “REL 2” is Not suppressed in Fire Alarm mode from control button “Outputs”;

The last optional application mode (Mode 1 or Mode 2 described above) is stored as a fixed configuration even after reboot of the fire control panel.

The default application mode of the panel is Mode 1.

6.4. Conditions of the Fire Control Panel

Fire control panel FS4000 monitors the fire alarm lines by consecutively scanning their condition. Depending on the current value, the line can be in normal condition, in fire condition or in a fault condition (short circuit or break). Simultaneously (if enabled) a constant control for removed fire detectors is being carried out, provided that the fire alarm installation is designed and completed as shown on the diagram of section 13.3. Control over the monitored outputs of fault condition (short circuit or break) is being carried out as well.

The fire control panel FS4000 operates in five basic modes: Duty Mode, Fire Condition, Fault Condition, Disabled Component Mode and Test Mode.



7. Duty mode

7.1. Description

The fire control panel is in Duty Mode, when it is not in Fire condition or in Fault condition.

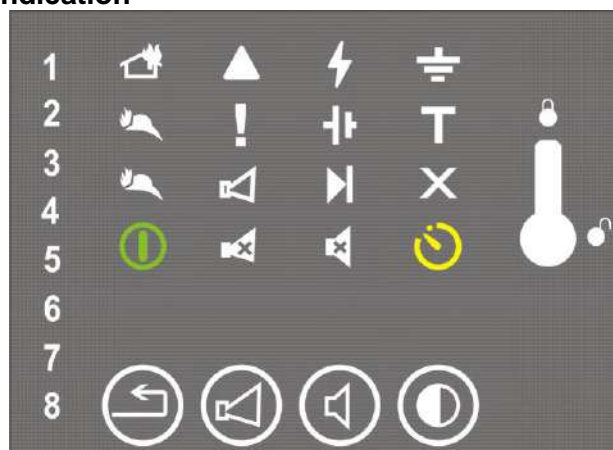
7.2. LED and sound indication



In Duty mode are active only the green LED indicator  (Power supply) and the yellow indicator  if a delay is set for the outputs. The local buzzer is off.

7.3. Using the buttons

Active buttons in Duty mode:

- pressing the button Test Indication and Buzzer  activate indication and sound signaling;
- Using the button  in this mode activates the monitored outputs (or suppresses them if they were activated). The aim is to signal for forced evacuation if necessary.

7.4. Additional option

In FS4000 there is opportunity for configuring line(s) in a definite way so that if signal for Fire condition, the Fire Control Panel enters directly in Fire condition 2ndstage. Configuring is described in section 10.2 and it is in accordance with Table 3. Setting a line in this mode is performed by manual operation of placing a pair of switchers in appropriate line positions (ON ON).

8. Fire condition

8.1. Description



The Fire Control Panel enters Fire condition upon double activation of a fire detector in any fire alarm line, for a period not longer than 60 seconds. After the first activation the control panel resets the fire alarm line for 3 seconds, and expects second activation in the next 60 sec. If activation occurs in this period, the Fire Control Panel enters Fire Condition. The Fire Control Panel can enter Fire condition in one fire alarm line or in a number of fire alarm lines.

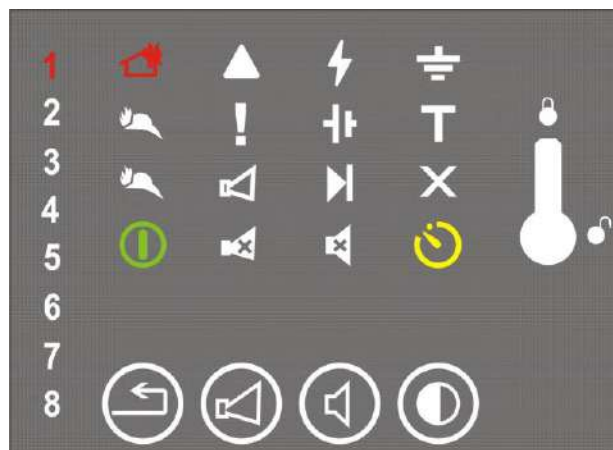

To exit Fire condition, press  button at Access level 2.

8.2. LED and sound indication



In this condition are illuminated :

- common indicator  with interrupted red light if Fire condition 1st stage and continuous red light if Fire condition is 2nd stage;
- Individual red LINE indicators from all lines of which the Fire Control Panel has indicated Fire condition;
- If the local buzzer is suppressed by button , the indicator  is illuminated with red light ;

- if the outputs are suppressed by button , then the indicator  is illuminated with red light; Local buzzer is activated.

If the Control Panel is connected with local network by Remote Control Panel for indication, the indicator  is illuminated in red light when receiving a confirmed signal for Fire condition from the Remote Panel FS5200R.

8.3. Using the buttons

8.3.1. Button (STOP/START Buzzer)

Press the button to:

- Switch off the local buzzer if it is activated due to Fire condition or Fault condition;
- Activate the local buzzer if the fire control panel is in Fire condition or Fault condition and the local buzzer is previously deactivated by the same button.

The LED indicator  is illuminated if the local buzzer is switched off for Fire condition or Fault condition.

The button does not affect and is not cancelled by the following events:

- Fire condition in new line ;
- New Fault condition will activate the local buzzer.

Access to the button is allowed at Access level 1, 2, 3.

8.3.2. Button (STOP/START Outputs)

The button operation depends on the current access level and the status of the fire control panel.

Where lines in Fire condition are available, press the button to:

- In case of suppressed outputs for fire condition – to force activation of the outputs;
- In case of activated outputs for fire condition – to suppress the outputs.

The LED indicator  illuminates if outputs for fire condition are suppressed.

8.3.3. Button (RESET FIRE)

Press it to force the control panel to exit Fire condition and to reset the lines (cuts off the power supply for 3 seconds).

Access to the button is allowed at Access level 2.

8.3.4. Reset fires input – “RST”

The remote fire reset input operation does not depend on the access level of the panel.

On short-circuit on the ‘RST’ input the fire condition of the panel will be reset and all zones in fire will be reset.

9. Fault condition

9.1. Description

The fire control panel enters Fault Condition when any of the events below has been registered:

- System fault;
- Battery Low – backup batteries discharged due to interruption in mains supply;
- Fault in a line – removed fire detector, short circuit or break;
- Fault in a monitored output – short circuit or break;
- Fault in main supply;
- Fault in backup batteries power supply;
- Short circuit or leakage to earth wire;
- Fault in power supply to lines;

- Fault in power supply to external devices;
- Network fault or fault in the transmitting device;



In System fault the main processor is not able to continue operation.

You can exit the System fault condition only if you disconnect the control panel from the mains supply and send it for repairs.







All other faults are not fatal and switch off some of the periphery devices only. The fire control panel exits the status automatically 8 s after the fault condition is eliminated.

In Fault condition terminals C and NC of relay output REL Fault are connected; when no fault condition is registered, terminals C and NO of the same output are connected.

9.2. LED and sound indication

In "Low Battery" no LED indicator. The indicator  (Fault Condition) flashes in steady yellow light, and indicators  (Fault in backup battery) and  (Fault in mains supply) flash in yellow light. The local buzzer is activated and releases interrupted signal.

In all other fault conditions the indicator  (Fault condition) flashes in yellow. Depending on the type of the fault condition the following indicators are illuminated:

- System fault - indicator  (System fault) is illuminated in yellow light;
- Fault in fire alarm line – Individual LINE indicators flashes in yellow to indicate:
 - ◆ Short circuit - 1Hz frequency /slow flashing light/;
 - ◆ Break in a line - 4Hz frequency /quick flashing light/;
 - ◆ Removed fire detector - 4Hz frequency, 1 second pause /interrupted, quick flashing light/.
- Fault condition in monitored output - indicator  FAULT in / Disabled monitored output) flashes in yellow light;
- Fault in backup batteries - indicator  (Backup battery fault) is illuminated in yellow light;
- Fault in power supply to external devices - indicator  (Fault in internal power supply) is illuminated in yellow light;
- Short circuit or leakage to earth wire - indicator  (Earth FAULT) is illuminated in yellow light.
- Fault in the local network or in the transmitting device  the indicator is illuminated in continuous yellow light.

The local buzzer is activated and produces discontinuous signal. If the sound indication has been

suppressed by button  (STOP/START Buzzer), the LED indicator  is illuminated in continuous red light.

9.3. Using the buttons

No buttons are active in System fault.

In all other fault conditions button  (START/STOP Buzzer) is active only. Press the button to:

- Switch off the local buzzer if it responded for Fire condition or Fault condition;
- Activate the local buzzer if the Fire control panel is in Fire condition or Fault condition and the local buzzer is previously suppressed by the same button.

The LED indicator  is illuminated, if the local buzzer is switched off for Fire condition or Fault condition.

The button does not affect nor is its action cancelled by the following events:

- When new line enters Fire condition, the local buzzer will be activated;
- When new fault condition is registered, the local buzzer will be activated.

Access to the button is allowed at Access level 1, 2, 3.

10. Disabled component mode

10.1. Description

The fire control panel enters Disabled component mode after a component has been manually disabled – a fire alarm line or a monitored output. The condition is set through microswitchers for each line separately, and also for outputs for fire condition – monitored and relay outputs.

The disabled line is switched off (the power supply is cut off) and is not monitored for activated fire detector and faults. The disabled outputs are switched off (the executive device can not operate) and the monitored output is not monitored for faults.

10.2. Disable/Enable a line:

Duty mode of lines is determined by a pair of switchers (pos.4, fig.1). Each line has a pair of switchers, whose position is determined by the operation mode (fig . 2)

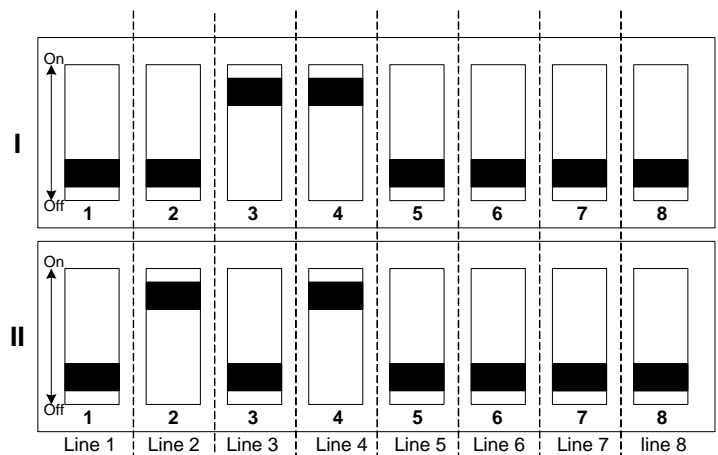

Fig. 2

For each individual line the following modes are possible (N - line number)

Table 3

Type of Mode	DIP N (I)	DIP N (II)
Duty mode	OFF	OFF
Test	OFF	ON
Disabled line	ON	OFF
Duty mode with direct indication of Fire condition 1 st stage	ON	ON

10.2.1 To disable a line

Move the pair of switchers of the line in position ON OFF according to table 3.

With continuous yellow light are illuminated :

- the Individual indicator of the line;
- the indicator **X** (if no other disabled components)



10.2.2. To cancel disabling a line

Move the pair of switchers of the disabled line in position OFF OFF in accordance with table 3.

Lights of the following indicators are switched off:

- Individual indicator of the line ;
- indicator **X** (if no other disabled components).

10.3. To Disable/Enable outputs in Fire condition

For time delay setting (table 5), for disabling monitored outputs , interface RS485, “Earth Fault”, “Check Rem. Det.” (table 4) and for free-programmable outputs (table 6) is used 10 pos DIP-switch (pos.3, fig .1)



Table 4

DIP	ON	OFF
1	Check for removed detector disabled	Check for removed detector enabled
2	Earth detection disabled	Earth detection enabled
3	Time delay See Table 5	
4		
5		
6	Disabled monitored outputs	Enabled monitored outputs
7	Communication interface RS485 is ON	Communication interface RS485 is OFF
8	User combinations See Table 6	
9		
10		

10.3.1. To disable monitored outputs

Move DIP 6 into position ON (Table 4).

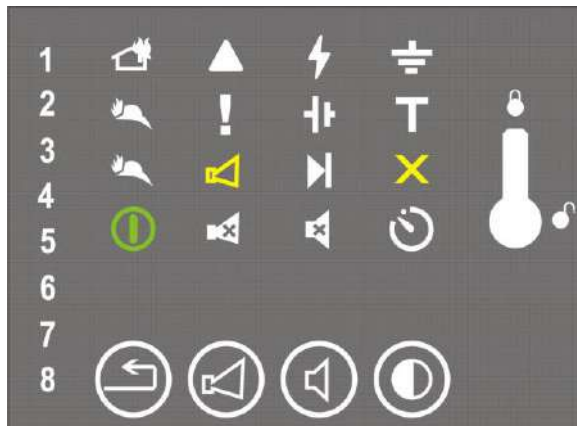

With continuous yellow light are illuminated:

- indicator  illuminated in continuous yellow light;
- left indicator  (if no other disabled components).

**10.3.2. To cancel the disabling of the monitored outputs**

Move DIP 6 into position OFF (Table 4).

Lights of the following indicators are switched off :

- indicator  ;
- left indicator  (if no other disabled components).

10.4. Switching ON/OFF communication interface RS485

The extension of FS4000 with module FD4201 allows the Fire Control Panel to participate in the local network composition and to communicate with other Fire control and Remote control panels

DIP 7 (pos 3, fig .1) define On and Off communication interface RS485 as follows:

Position ON – communication interface is switched ON;

Position OFF – communication interface is switched OFF;

For Disabled component mode no sound indication is supported.

10.5.Enable/Disable “EARTH detection”:

10.5.1. When the Fire Control panel operates altogether with spark protection unit , the “EARTH detection“ function is need to be disabled:

- Move DIP 2 (pos.3, fig.1 and Table 4) into position “On”;

10.5.2. Enable “EARTH detection” function:

- Move DIP 2 (pos.3, fig.1 and Table 4) into position “Off”.

10.6.Enable/Disable “Check Rem.Det”:

10.6.1. Disable “Check Rem. Det.”:

- Move DIP 1 (pos.3, fig.1 and Table 4) into position “On”;

10.6.2. Enable “EARTH detection” function:

- Move DIP 1 (pos.3, fig.1 and Table 4) into position “Off”.

11. Test condition

11.1. Description

The Fire control panel enters Test Mode after a fire alarm line has been manually set to operate in test condition. Test Mode condition is set by a pair of DIP-switches (pos.4, fig.1). Each line has a pair of switchers, whose position is determined by the operation mode (fig.2) of each separate line.

The Fire Control Panel provides option for testing LED and sound signaling indication.

Pressing and holding the button  illuminates all lights and LEDs and activates the buzzer.



11.2. Line in Test condition

When a fire alarm line is in test condition, the following operational changes are in effect:

- upon registration of Fire condition in this line the sound indications, light indications, associated outputs do not operate;
- upon registration of Fault in a line the sound indicators, light indicators and the relay output for fault condition do not operate;
- the line is being automatically reset (the power supply is interrupted for 3 s) every 64s.

11.2.1. Setting a line in Test condition

Move the pair of switchers into position (OFF ON) according to Table 3.

In this condition are illuminated:

- the individual indicators of the line with flashing orange light ;
- the indicator with continuous yellow light  (if there were no lines in test condition).

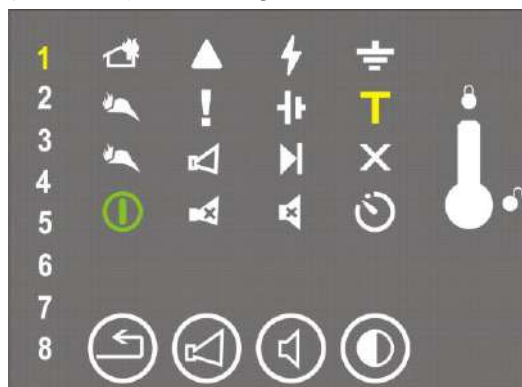

11.2.2. To cancel Test Condition of a line

Move the pair of switchers into position (OFF OFF) according to Table 3.

The following lights are switched off:

- Individual yellow line indicators;
- indicator  (if no other lines are set to test condition).

12. Delay of outputs

12.1. Description

The Fire control Panel registers the time delay of the outputs after manual operation for setting the appropriate value. The time delay is set by a combination of 3rd, 4th and 5th position of DIP-switch (pos.3, Figure 1 and Table 4) and can be 0, 1, 2, 3, 4, 5, 6 or 7 minutes. At time delay set to "0" – the outputs are activated immediately after the Fire control panel enters Fire condition.

Time delay setting is performed by moving the 3rd, 4th and 5th position of DIP-switch (pos 3, fig .1) in the following tables :

Table 5

DIP	0 minutes	1 minute	2 minutes	3 minutes	4 minutes	5 minutes	6 minutes	7 minutes
3	OFF	OFF	OFF	OFF	ON	ON	ON	ON
4	OFF	OFF	ON	ON	OFF	OFF	ON	ON
5	OFF	ON	OFF	ON	OFF	ON	OFF	ON



When the time delay is set to $\neq 0$, the indicator is illuminated with continuous yellow light

13. User configuration of the outputs

The Fire Control Panel provides the option for inserting combinations for outputs activation .8 constant combinations are set. An operating combination shall be chosen by 8th, 9th, and 10th position of DIP-switch (pos.3, fig.1).

Possible combinations are given in Table 6.

Table 6

			Rel 1	Rel 2	Out 1	Out 2
1	DIP	position	Switches On immediately	Switches On with time delay	Switches On with time delay	Switches On with time delay
	8	OFF				
	9	OFF				
2	DIP	position	Switches On immediately	Switches On immediately	Switches On with time delay	Switches On with time delay
	8	OFF				
	9	OFF				
3	DIP	position	Switches On with time delay	Switches On with time delay	Switches On with time delay	Switches On with time delay
	8	OFF				
	9	ON				
4	DIP	position	Switches On with time delay	Switches On with time delay	Switches On immediately	Switches On immediately
	8	OFF				
	9	ON				
5	DIP	position	Switches On only in Fire condition of line 1	Switches On only in Fire condition of line 2	Switches On with time delay	Switches On with time delay
	8	ON				
	9	OFF				
		10	OFF			

6	DIP	position	Switches On only in Fire condition of lines 1 or 2	Switches On only in Fire condition of lines 3 or 4	Switches On with time delay	Switches On with time delay
	8	ON				
	9	OFF				
7	DIP	position	Switches On only in Fire condition of lines 1 and 2	Switches On only in Fire condition of lines 3 and 4	Switches On with time delay	Switches On with time delay
	8	ON				
	9	ON				
8	DIP	position	Switches On only in Fire condition of line 1,2,3 or 4	Switches On only in Fire condition of line 5,6,7 or 8	Switches On with time delay	Switches On with time delay
	8	ON				
	9	ON				
	10	ON				

14. Installation and initial start of the fire control panel

14.1. Preliminary installation steps

- Unpack the panel and pull-up the front cover (pos.1, fig.3)

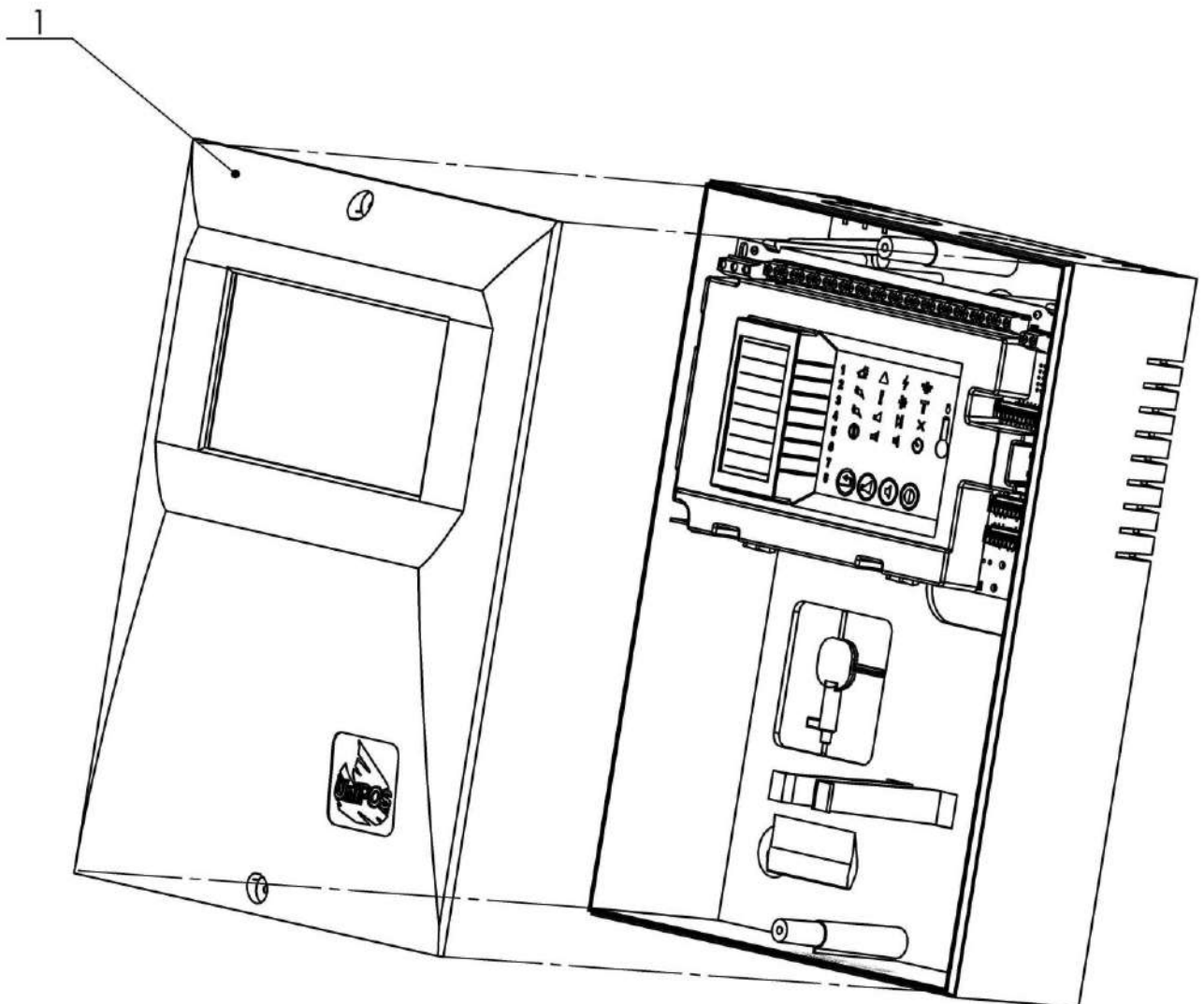

Fig.3

- Pull-out the interface board (fig.4) following the sequence:
- push the holders on the top side (fig.4, pos.1);
 - take out (from the top holders) the interface board and leave it fixed on the bottom holders (fig.4, pos. 2);
 - pull the interface board out of the bottom side holders (fig.4, pos. 3), till fully released;

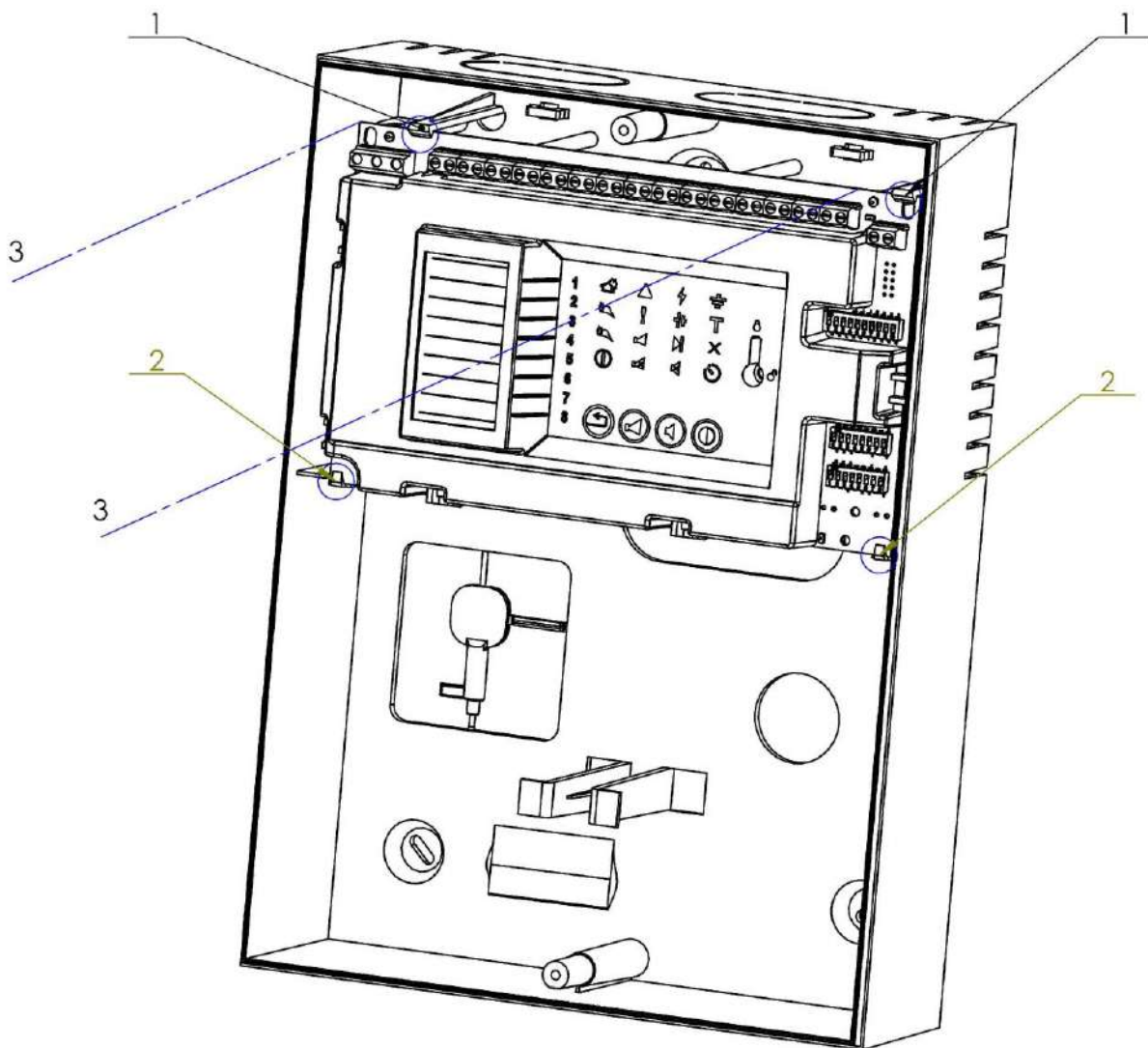

Fig.4

- Cut the access level key out from the bottom side of the cabinet (fig.5, pos.3);
- Cut the plastic plugs out from the bottom side of the cabinet (fig.5, pos.2);

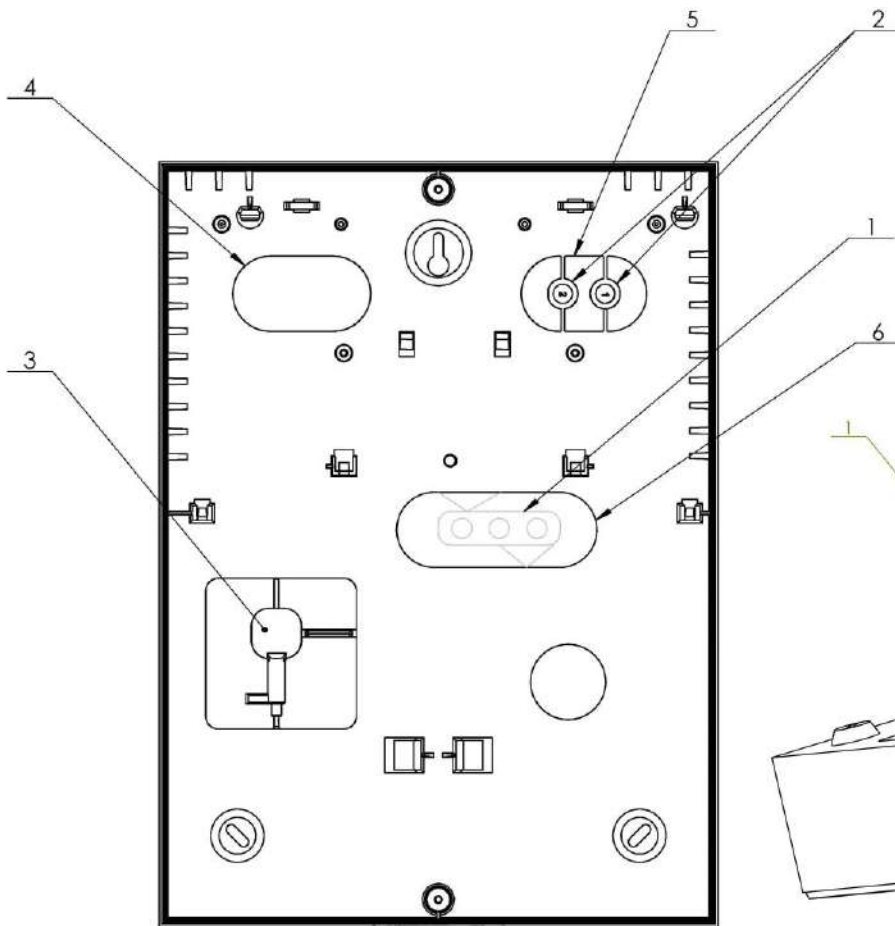

Fig.5

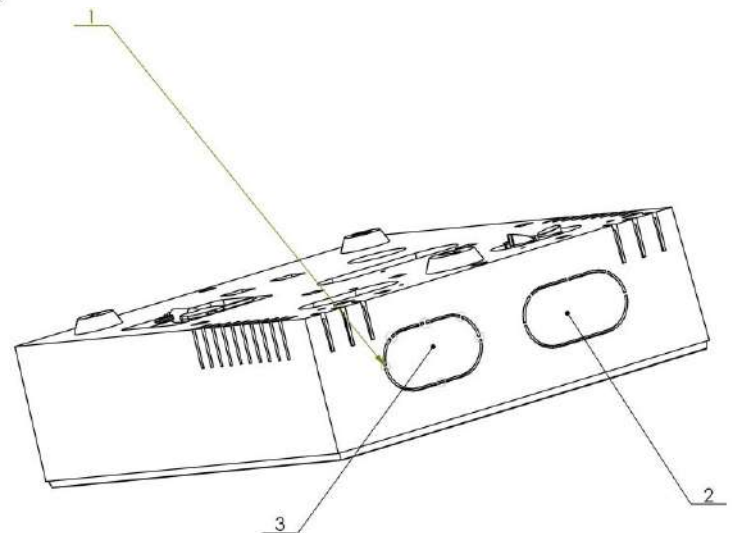

Fig.6

14.1.2. Prepare the cable openings

- Take care to fully clean the opening on fig.5, pos.5;
- Do not remove the plastic component (fig.5, pos.1);
- The openings (fig.5, pos.6) and (fig.5, pos.5) are dedicated to the signal lines (conventional zones and alarm and protection equipment);
- The opening in the top left corner is only dedicated to the 220Vac mains power line (fig.5, pos.4), applicable for the FS4000 mains power supply;
- The external opening, located on the topside of the cabinet are dedicated for surface mounting of the signal line (fig.6, pos.2) and mains power line (fig.6, pos.3);

14.1.3. Preparation of the necessary cables in the cabinet of the FCP.

- The length of the mains cable line (220 Vac), placed inside the cabinet must be 185 mm, as marked on the draft fig.7(A);

- The length of the signal line cables, placed inside the cabinet must be 300 mm, as marked on the draft fig.7(B).

As a result, the wires will be flexible enough to move the interface board inside the cabinet, with the signal lines already connected to the FCP connectors.

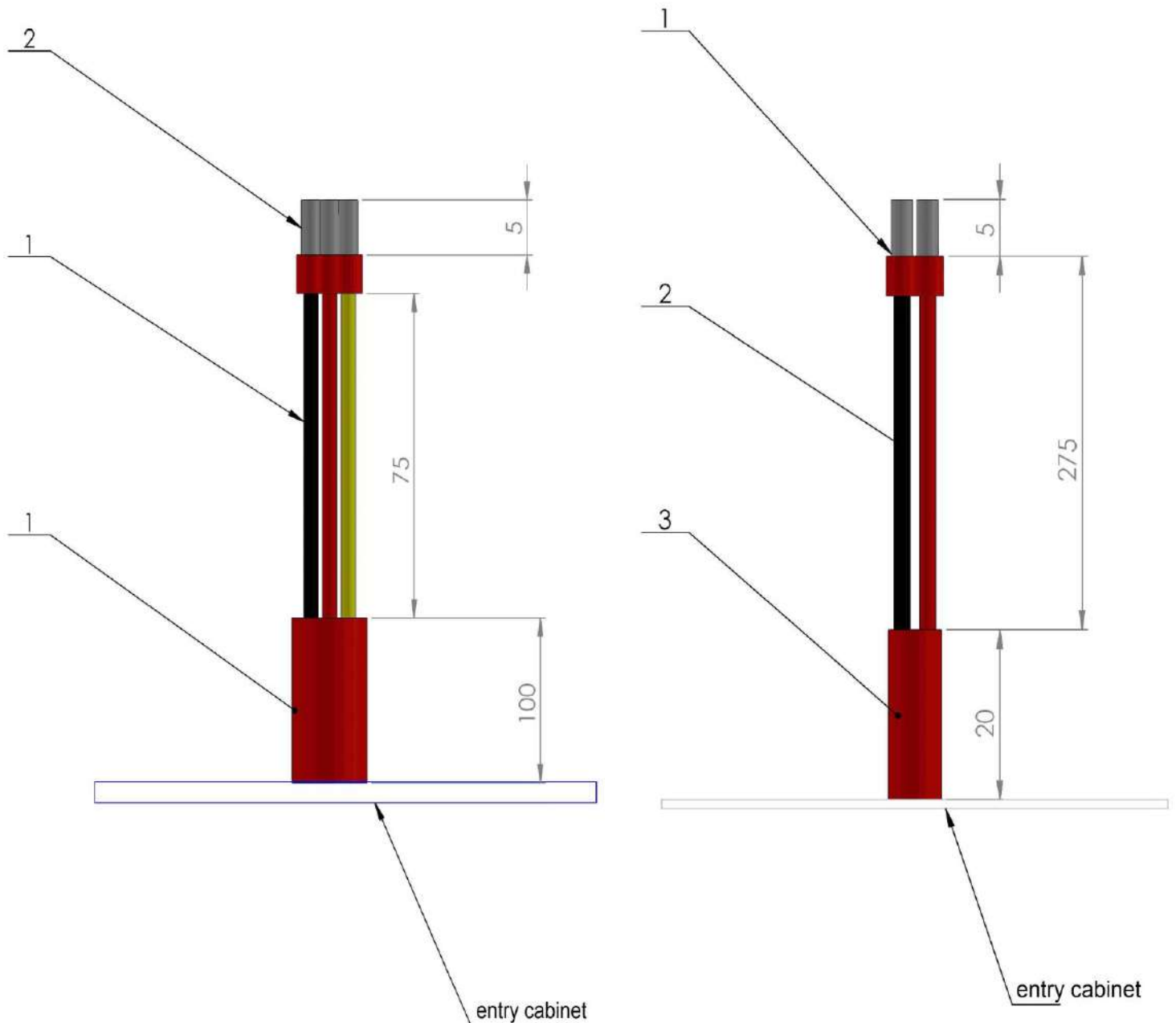

Fig.7.(A)

Fig.7.(B)

14.1.4. Prepare and choice of place to installation FCP cabinet.

- The distance between the wall and the backside of the FCP cabinet is 7 mm (fig. 8). For correct installation, there should be no cables or obstacles in the gap between the cabinet and the wall, which are more than 7 mm (fig.8, pos.1);
- The FCP must not be installed in location close to heat sources like refrigerators, air-conditioners or similar;
- The dedicated cabinet openings (fig.8, pos.2) must to be free, for proper heat convection.

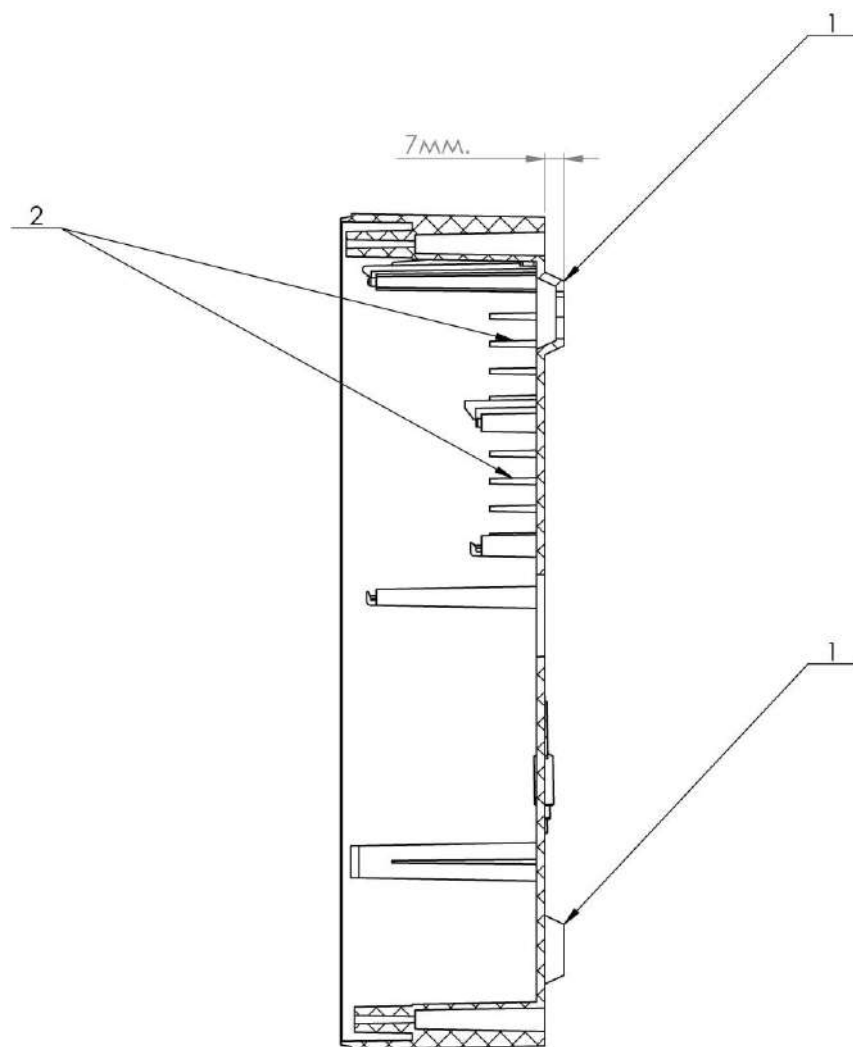

Fig.8

Put the panel's cabinet on the wall and mark the positions for the dowels (fig.9, pos.1).

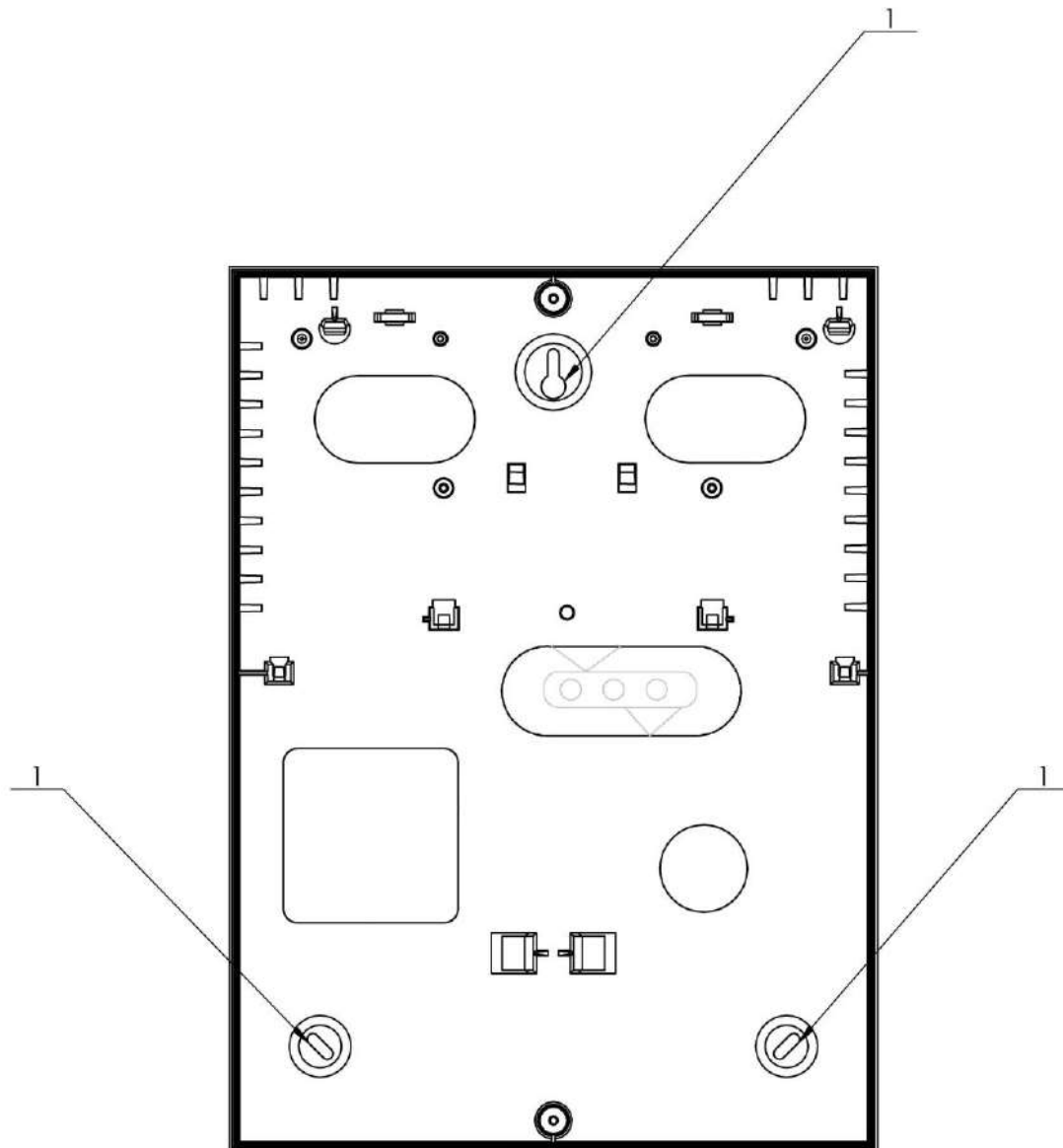

Fig.9

- Take the signal and power lines through the dedicated openings (refer p.14.1.2) and mount the screws (fig.9 pos.1) and fix cabinet on the wall.

14.1.5. The signal lines and mains power line (220VAC) prepare to connect to main interface board.

- The mains power line, passing through the dedicated opening (p.14.1.2) is fixed with tie-wraps in the cabinet on fig.10, pos.1.
- The signal lines, passing through the dedicated opening (refer p.14.1.2) is fixed with tie-wraps in the cabinet on fig.10, pos.2 and fig.10, pos.3.

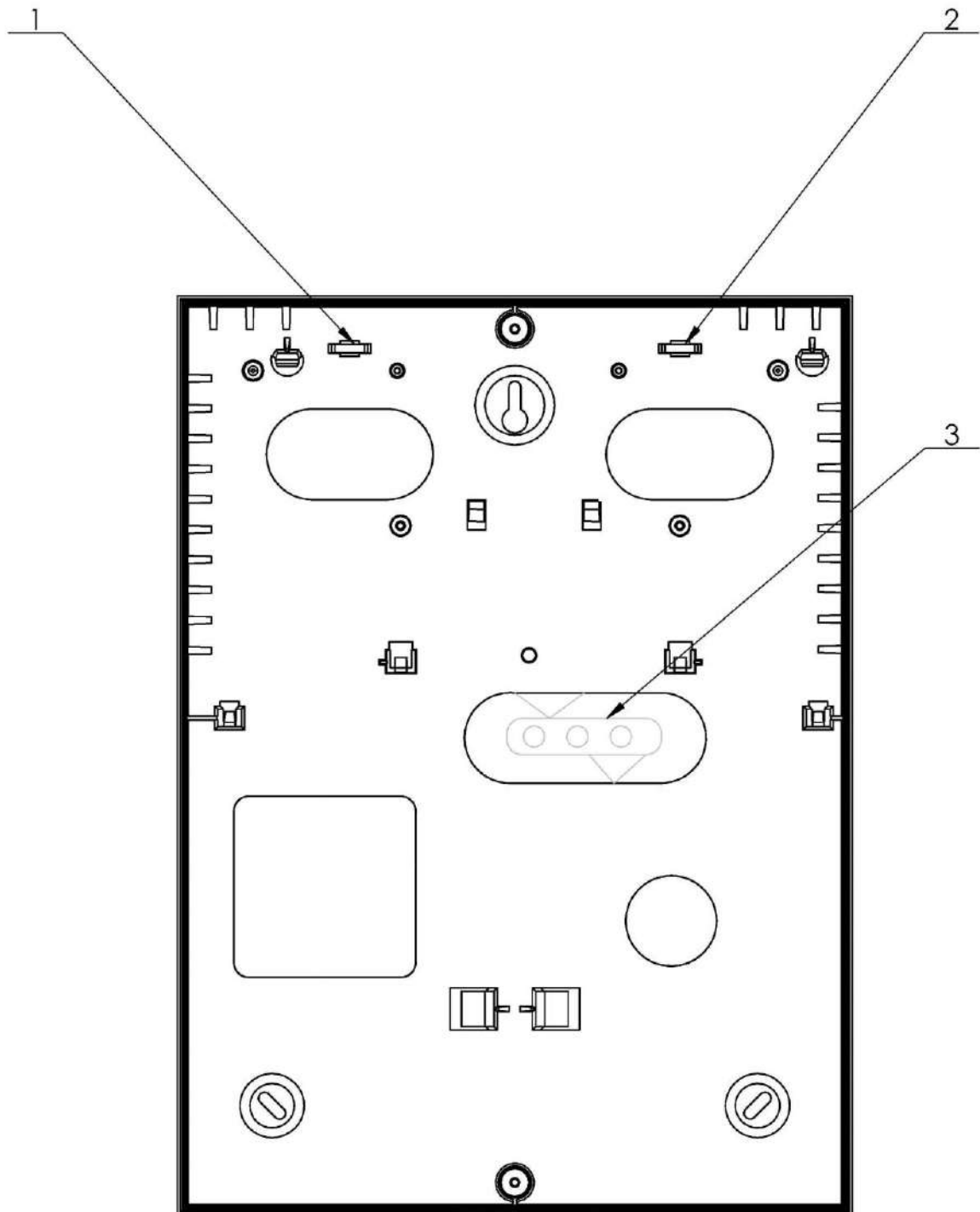

Fig.10

14.1.6. The signal lines cable connection to main interface board.

- For easy wires installation in the PCB connectors, the interface board is mounted to the bottom holders, as illustrated on fig.11, pos.1.
- The signal cable lines, dedicated for the conventional zones and fire protection and fire alarm equipment, are fit to the PCB connectors in the main interface board (fig.11, pos. 2), without being fully tighten. The mains cable is not connected in the PCB connector on this stage, but later on when the interface board is in its initial position (refer p.4.1.8).

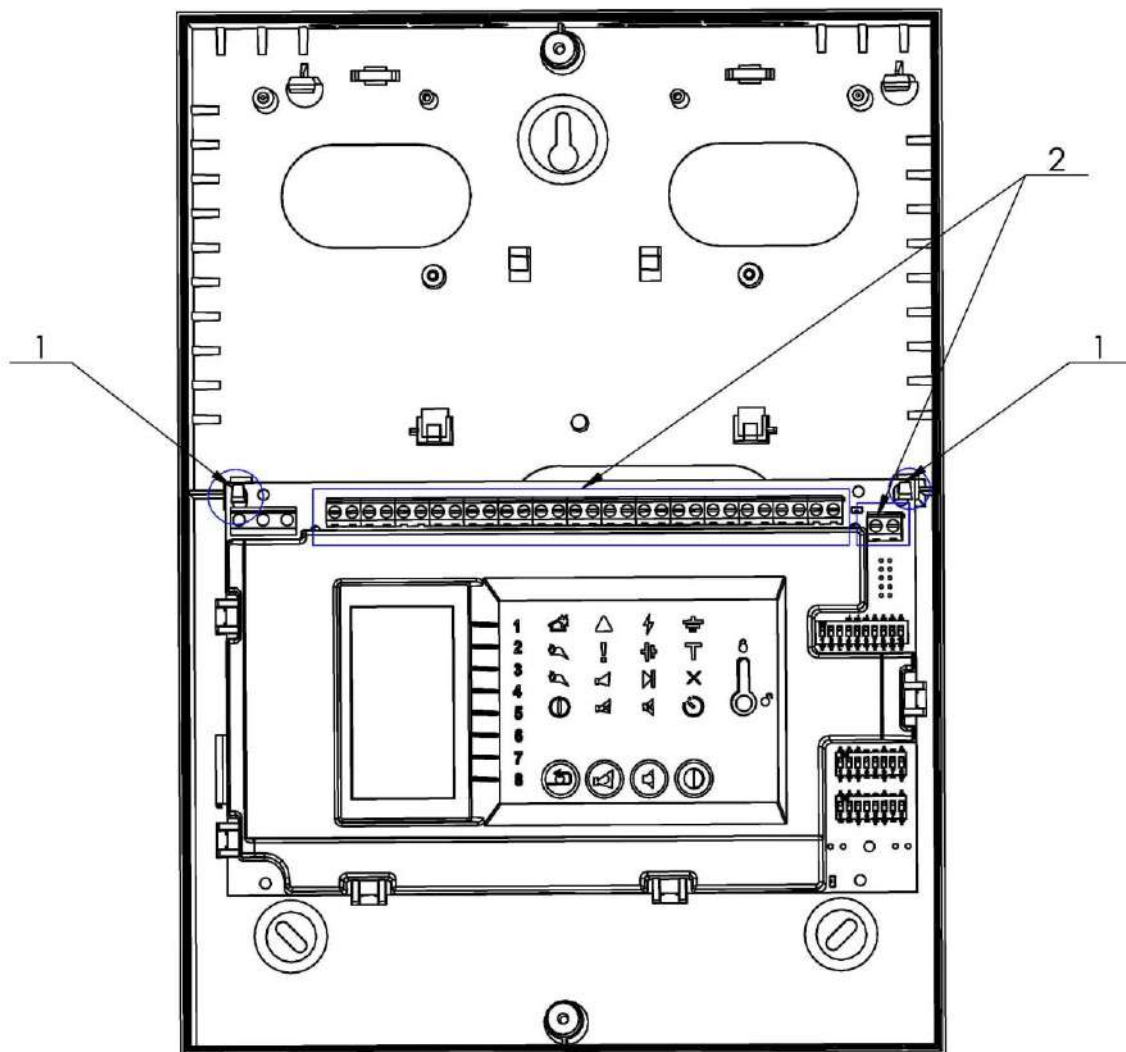

Fig.11

14.1.7. Mains power line (220VAC) connection to the main interface board.

The interface board is put back to its initial position (Fig.12) :

- The bottom side of the interface board is mounted on the holders (fig.12, pos.1);
- The top side of the interface board is pushed until the top-side holders click to fix it (fig.12,pos.3);
- The power line is connected in the PCB connector in FCP (fig.12, pos.4);
- Fully tighten the signal line cables, dedicated to the conventional zones and fire alarm and protection equipment (fig.12, pos.5).

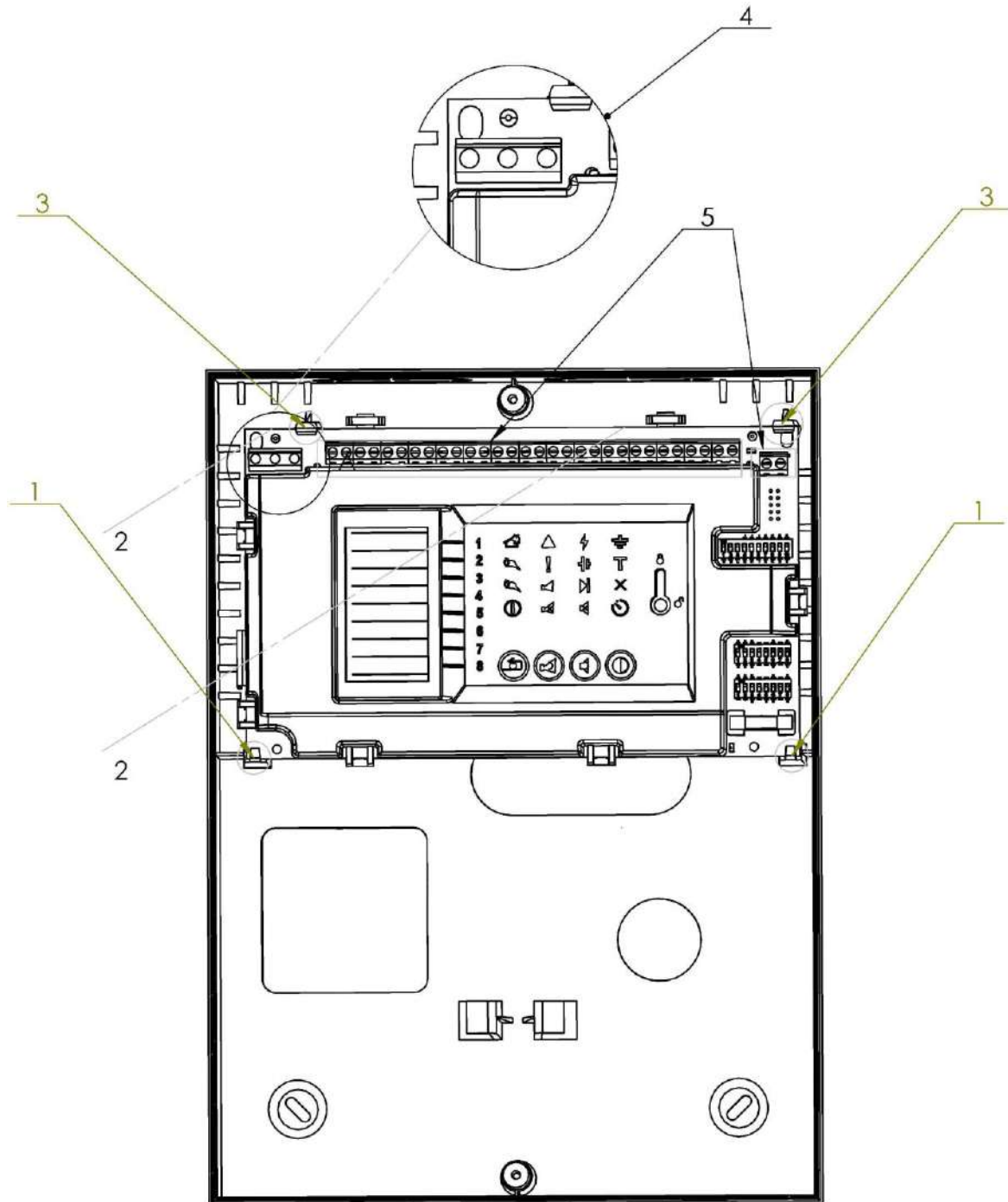

Fig.12

14.1.8. Installation of the back-up batteries in FCP.

- Install the back-up batteries in the cabinet of the FCP (fig.13, pos.1). The maximum capacity of the batteries is 7 Ah, but it is correct to install 1.2 Ah or 4.5 Ah back-up batteries, as well.

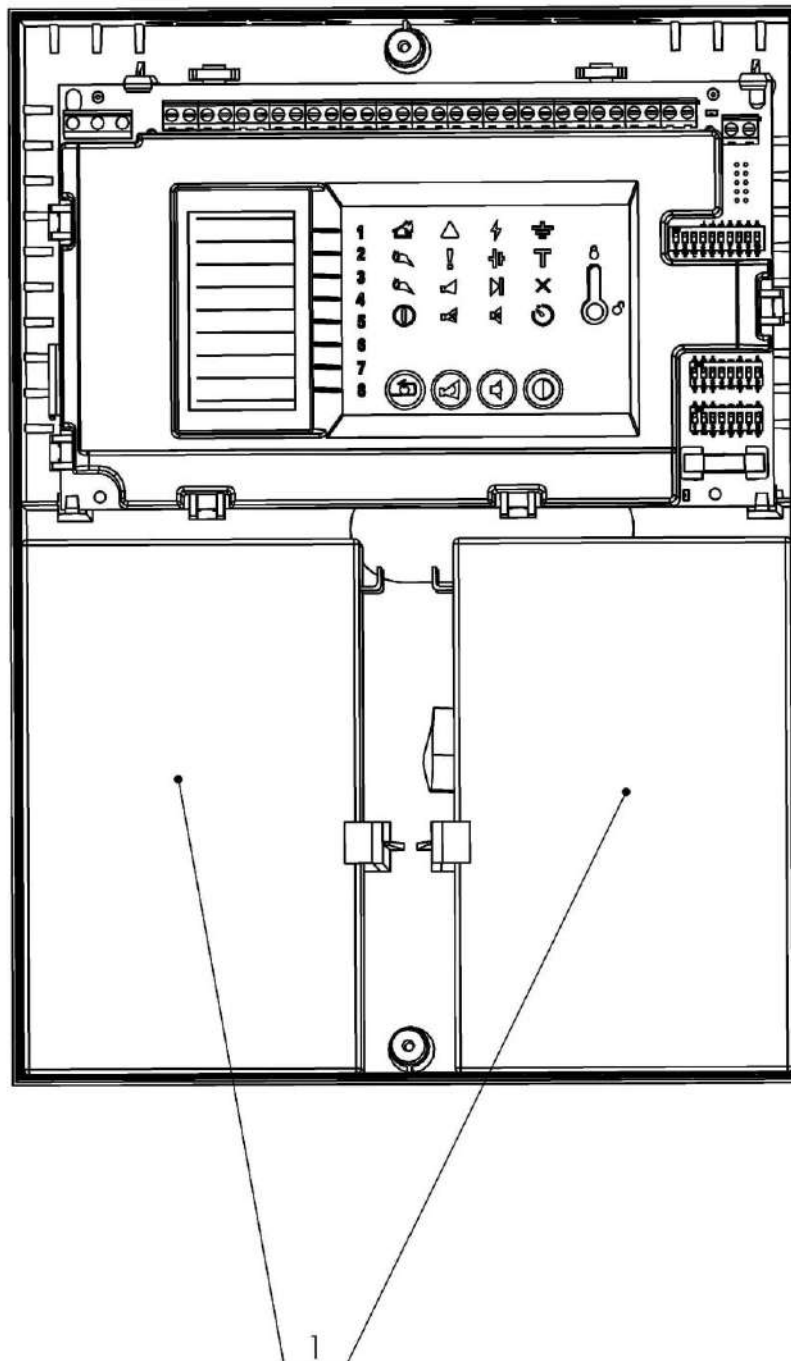

Fig.13

14.1.9. Close the cabinet.

- Fit the front cover of the cabinet to its initial position (fig.14);
- Install the screws in the dedicated openings of the front cover (fig.14, pos.1 and pos.2);
- Put the plastic plugs to hide the screws (fig.14, pos.3);
- Install the access level key (fig.14, pos.4);

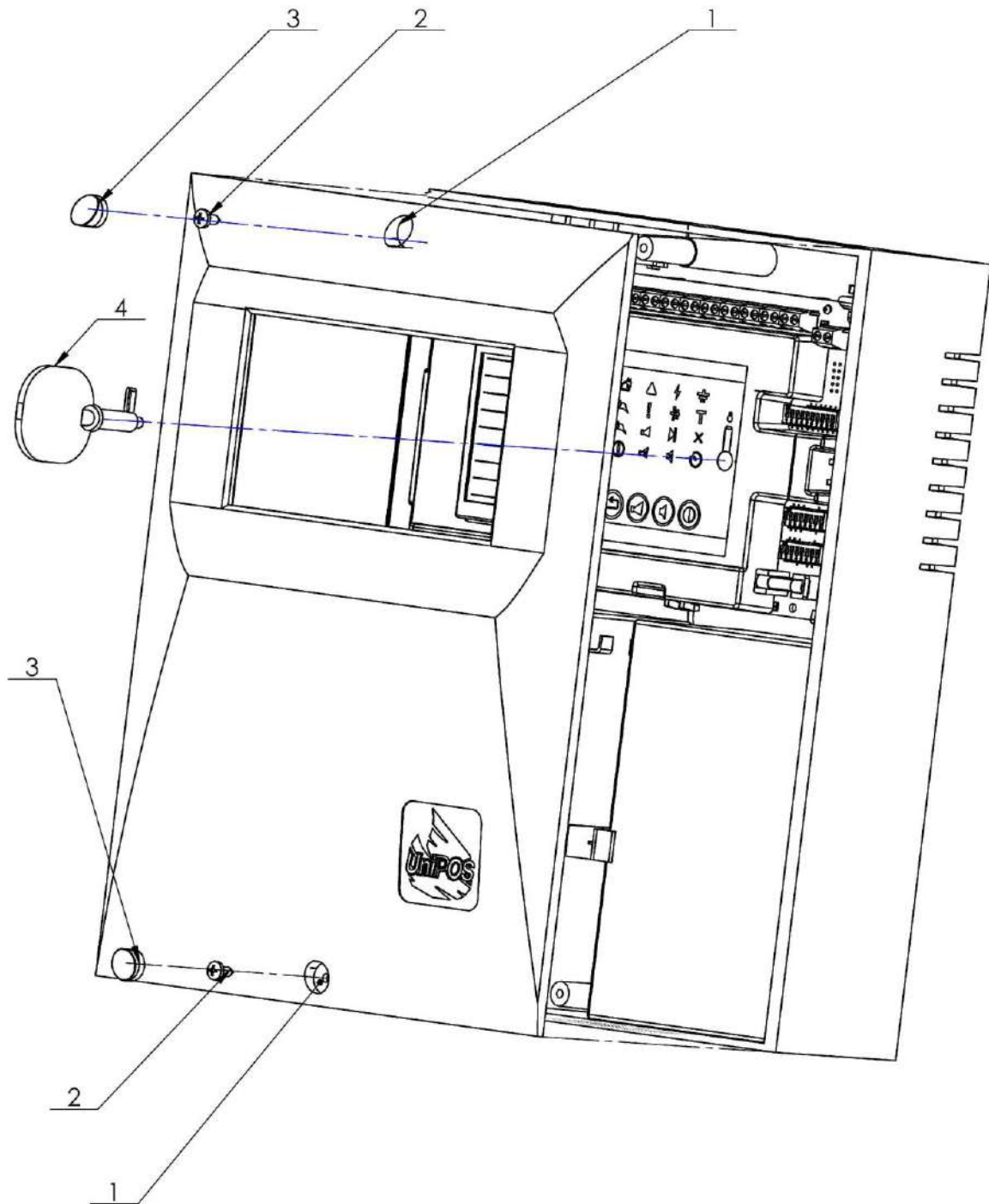

Fig.14

14.2. Periphery devices assembly

All connections are to be made by means of terminals, mounted on the printed circuit boards . Be advised, that the total consumption of the voltage powering the external devices (terminal "+ 24V") shall not exceed 1,2 A in heavy duty mode.

14.2.1. Mounting periphery devices to monitored outputs

Terminals "+Outx", "-Outx" - monitored potential output, activated in Fire condition shall be used. The fire control panel constantly monitors the power supply line for Fault conditions (break or short circuit).

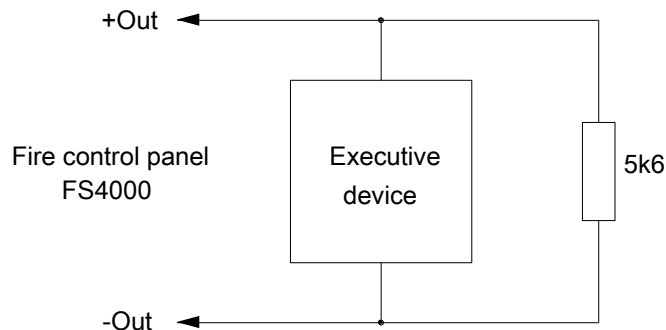

If the monitored output is not in use, fix a resistor 5k6/0,25W immediately to terminals "+Outx" and "-Outx".

14.2.2. Mounting periphery devices to relay outputs

Use:

- terminal "+24V" – positive lead of the stabilized direct current supplying the external devices (light and sound signaling devices, executing devices and others);
- terminal "GND" – chassis (negative lead of the stabilized direct current supplying the external devices);
- terminals "REL Fault/C", "REL Fault/NO" и "REL Fault/NC" - potential free relay contacts. Terminals "REL Fault/C" and "REL Fault/NO" are connected where no fault condition is registered; terminals "REL Fault/C" and "REL Fault/NC" where fault condition is registered.
- terminals "REL1/C", "REL1/NO" and "REL1/NC" - potential free relay contacts of REL1. In duty mode there is a connection between terminals "REL1/C" and "REL1/NC", and in Fire condition between terminals "REL1/C" и "REL1/NO".
- terminals "REL2/C" and "REL2/NO" - potential free relay contacts of relay REL2. In duty mode there is no connection between terminals "REL2/C" and "REL2/NO", in Fire condition there is a connection between terminals "REL2/C" and "REL2/NO".

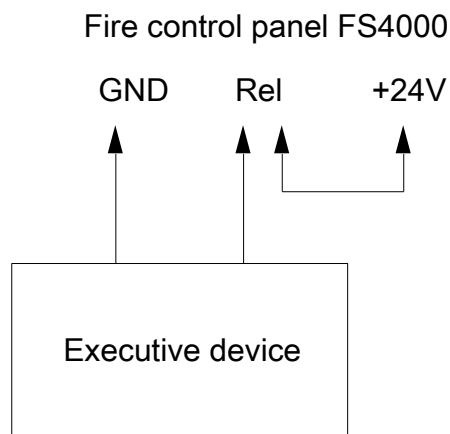

Fig.3

Unused relay outputs remain free (the terminals are not occupied).

14.2.3. Connection of extension module FD 4201

In Fire Control Panel FS 4000 there is a option for extension through module FD 4201.

The module FD4201:

- expand the panel's outputs with additional 2, 4, 6 or 8 (depend from number of the lines in the panel) relay non-potential outputs, activated trough fire;
- add interface RS485 for connection of the panel to local network. The connection between the panel and the module is by connector on the panel.

14.3. Connecting Remote Reset Input / “Activate monitored outputs”

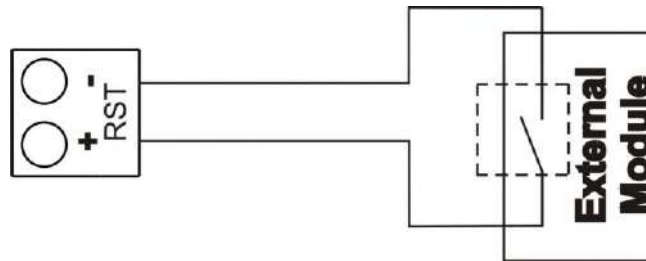

14.4. Connecting fire detectors

Fire detectors are connected to the fire control panel by means of two-wire insulated line of total resistance up to 100Ω. Recommended cross section of the wires depending on the length of the line is:

- ♦ Up to 500 m -cable 2 x 0.5 mm²
- ♦ Up to 1000 m -cable 2 x 1.0 mm²
- ♦ Up to 1500 m -cable 2 x 1.5 mm²

Before connecting a fire alarm line to the control panel, run a check with measuring equipment. Where the installation is completed correctly resistor 3,0 kOhm / 0.6W (or EOL module) is mounted between the + and the – of the cable, entering the control panel, a resistance of 3.0 kOhm (+/-10%) shall be measured. Also, check both cables to “Earth” and the measuring equipment shall display that no leakage or connection is registered.

Complete the connection using the terminals of the corresponding line “+L x” and “-L x” (where “x” is the number of the line); follow the designated polarity.

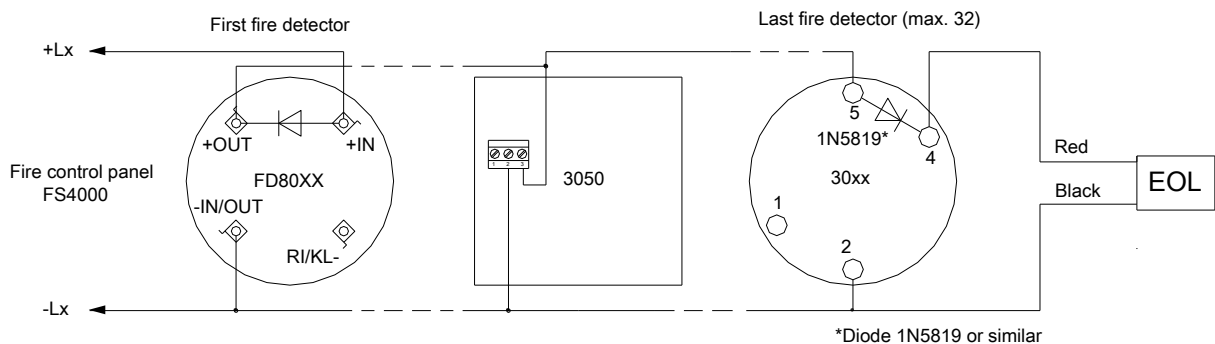

Automatic fire detectors of series FD3000 and FD8000 or compatible can be used. To enable detection of Fault condition *Removed fire detector* diodes shall be mounted – for example 1N5819, at the indicated direction. The manual call points shall respond with current $\geq 44\text{mA}$ at voltage 24V. You can use FD3050 Manual Call Point or compatible.

Up to 32 fire detectors can be integrated in one fire alarm line regardless of their type.

End of line resistor (or End of line module EOL if “Check Rem. Det” Is enabled) shall be connected directly to the terminals of unused fire alarm lines, otherwise the lines will trigger Fault condition.

14.5. Connection to power supply

Connect a feeding cable to the terminal 220V on the PCB (indicated L, E, N), observing the following positions :

- L – power wire “Phase”;
- E – protective earth wire;
- N – power wire “Null”.

The cable shall be double insulated and of 0,5mm² section for the power supply wires, and of 1,5mm² section for the protective earth wire.

The other end of the feeding cable is connected to the mains power supply by means of junction box.

The mains power supply of the fire control panel shall be in a separate loop.

15. Fire control panel start up

- Make sure that the connection to mains power supply is properly completed.
- Make sure that the periphery devices are correctly connected.
- Supply voltage to mains terminal and all LEDs shall illuminate for a short time, then the control panel starts operation.
- Connect the feeding cable and the backup batteries; the batteries shall be in a series connection.
- Connect the red wire to the positive backup battery pole, and the blue wire - to the negative pole. The overall voltage of both batteries must be over 18V, otherwise the fire extinguishing control panel will not recognize them.
- Configuring if necessary:
 - Time delay
 - Switching On/Off communication interface
 - User combinations for activating outputs
 - Check Rem. Det.
 - Earth detection
- If necessary attach a card with inscribed text for each line.

16. Conditions of operation, storage and transportation

16.1. Operation and storage

The fire control panel shall operate and be kept in closed premises, under the following conditions:

16.1.1. Temperature:

- | | | |
|------------------|---|--------------------|
| - storage | - | 5°C to 35°C |
| - transportation | - | minus 10°C to 50°C |
| - operation | - | minus 5°C to 40°C |

16.1.2. Relative humidity:

- | | | |
|-------------|---|-----------|
| - storage | - | up to 80% |
| - operation | - | up to 93% |

16.2. Transportation

The fire control panel shall be transported by vehicles, in factory packing, in the above stated environmental conditions and at sinusoidal vibrations with acceleration amplitude not more than 4,9m/s² in frequency range 10 to 150Hz.

17. Warranty

The producer guarantees compliance of the unit with EN 54-2: 1997/ A1:2006/AC: 2009, EN 54-4:1997/A2: 2006/AC 2009. The warrant period is 24 months from the date of the purchase, providing that

- the conditions of storage and transportation have been observed;
- the startup has been done by authorized personnel only;
- the requirements for operation stated herein have been observed.

UniPOS wishes you a successful work!

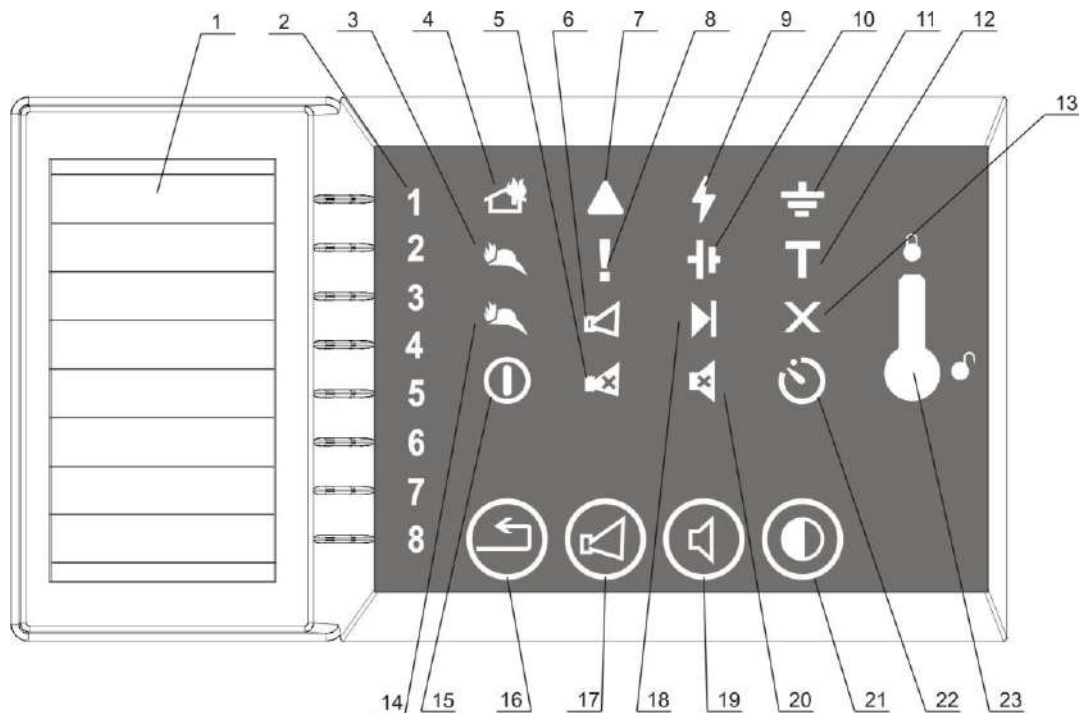
18. Appendixes**Appendix 1**

1. Area for LINE labeling
2. Individual LINE indicators for FIRE (red) and FAULT (yellow) condition
3. *Confirmed fire condition from the Remote Control Panel (red)*
4. Common indicator FIRE condition (red)
5. Indicator *STOP/START Outputs (red)*
6. Indicator *FAULT in/Disabled monitored output (yellow)*
7. Indicator *System fault (yellow)*
8. Common indicator for FAULT condition (yellow)
9. Indicator *FAULT in mains power supply (yellow)*
10. Indicator *FAULT in back up battery power supply (yellow)*
11. Indicator *Earth FAULT (yellow)*
12. Indicator *TEST condition (yellow)*
13. Indicator *Disabled component (yellow)*
14. Indicator *FAULT in Communication interface RS485 (yellow)*
15. Indicator *Power Supply (green)*
16. Button *RESET FIRE*
17. Button *STOP/START Outputs*
18. Indicator *FAULT in internal supply units (yellow)*
19. Button *STOP/START Buzzer*
20. Indicator *STOP/START Buzzer (red)*
21. Button *Test Indication and Buzzer*
22. Indicator *Delay of FIRE Outputs (yellow)*
23. Keyswitch "Access level 1" / "Access level 2"

Front panel of FS4000

Appendix 2

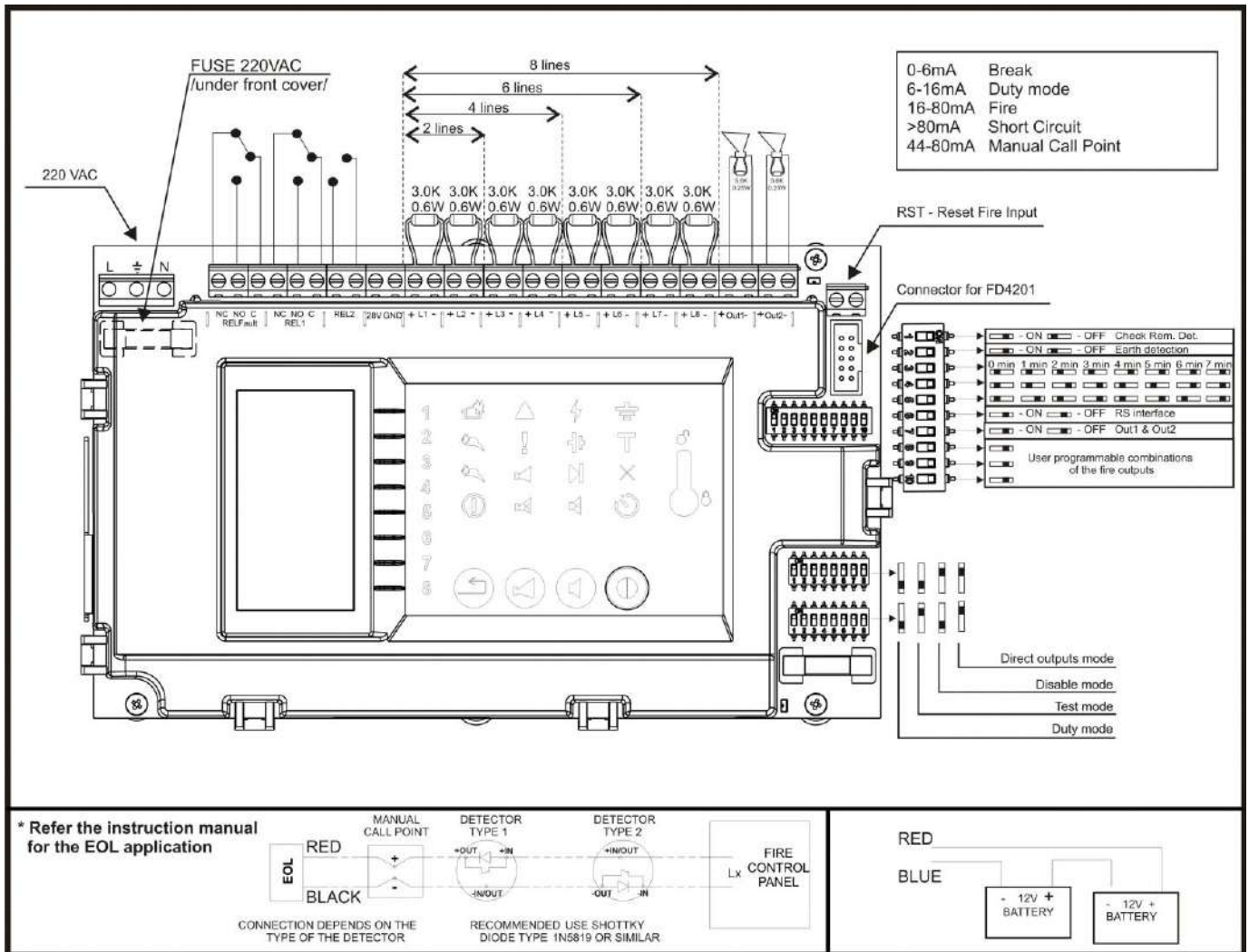

UniPOS

47, "San Stefano" Str., 5800 Pleven, BULGARIA
phone +359 64 891 100, fax +359 64 891 110
e-mail: office_pleven@unipos-bg.com

1, Efr. N. Paskalev, Str. Mladost 1, 1784 Sofia, BULGARIA
phone/fax +359 2 9744469, +359 2 9743925
e-mail: office_sofia@unipos-bg.com

www.unipos-bg.com