



# Addressable Natural Gas Detector

TYPE :71CNG

INSTRUCTION MANUAL 01-71CNG-07-18



## GENERAL DESCRIPTION

The 71CNG detector (fig.1) is applicable for detection of natural gas (methane) in the protected area. The status of the detector is indicated with its built-in LEDs and built-in Sounder and meanwhile monitored and controlled from the IFS7002 addressable fire control panel.

The 71CNG is compliant with the EN50194-1 standard on the following trigger level – 5, 000 ppm CNG (methane) in air, saturation 10% LEL ( Low Explosion Level) of the protected area.

The 71CNG is with built-in signal interface and aux. power interface (refer fig.3). The signal loop interface is dedicated for communication with fire control panel IFS7002 through the UniTalk private protocol. The signal loop is fail-safe with 71CNG built-in short circuit isolator.

The aux. power interface is dedicated for the supply of the high-load components of the detector - activation of the built-in sounder and heating of the built-in semiconductor sensor.

Both power supplies are galvanic-separated and must not be with common ground. The common ground will not damage the operation of the 71CNG, but will affect the communication between the detector and the IFS7002 control panel.







Fig.1

## TECHNICAL DATA

Maximum number of 71CNG detectors in the IFS7002 signal loop:	125 pcs.
Supply voltage :	
- signal loop	(15-30) V DC
- power loop	(18-30) V DC
Current consumption in Duty mode:	
- signal loop	< 350μA
- power loop	55 mA
Current consumption in Alarm mode :	
- signal loop	(2±1)mA
- power loop	75 mA
Sound level	100dB@1m
Temperature:	from minus 5°C to 40°C
Degree of protection	IPX2D
Relative humidity resiatance (no condensation)	≤ 95%
Dimensions	(134x36x112)mm
Weight	0.115kg.
Construction:	ABS

## CONTROL AND INDICATIONS

The 71CNG detector's functions are indicated through the following LEDs (fig1 pos.1):

INDICATORS SUMMARY	FUNCTIONS
	<b>green</b> - indicates the power-up status of the detector - its 28Vdc power supply and the 5Vdc power supply (dedicated to the heating of the sensor);
	<b>yellow</b> – indicates fault and service status. In case that the yellow LED is blinking, then the gas sensor is in heating (warm-up) procedure, which lasts for 120 seconds. In case that the yellow led is continuous On, then there is fault in the 71CNG detector;
	<b>red</b> – alarm – a methane level over the calibrated trigger level is detected in the device;
and  	<b>red</b> and <b>yellow</b> – are activated simultaneously with continuous ON in case of service command in the IFS7002 control panel (menu setup>Initialization>Check). Both LEDs flash simultaneously in a period of 16 sec. In order to indicate duty operation mode of the sensor;

**1.1 Test mode:** The 71CNG's built-in test button "T"  - is dedicated for test trigger of the LED and sound indication of the 71CNG detector.

The indicators are activated as long as the button is pressed and holded.

**Note:** Do not hold the button for more than 5 seconds.

**1.2 Duty mode:** On power-up, while the **yellow**  LED is blinking, then the gas sensor is in service mode with heating (warm-up) procedure of the sensor. This service period lasts for 120 seconds. In duty mode the 71CNG detector monitors the level of the methane in the protected area.

The **red**  and **yellow**  LEDs flash simultaneously in a period of 16 sec.

**1.3 Alarm mode:** The 71CNG detector is in alarm mode when the methane level in the protected area is higher than the factory calibrated trigger level. The **red**  LED indicator is continuously On. The sound beeper is continuously On with a frequency of 3 Khz.

All alarm indicators ( LED and sound ) could not be reset until methane level is below trigger level.

ATTENTION !!! IN CASE OF ALARM FOLLOW THE INSTRUCTIONS:

- Put out any flames;
- Close the gas tap or the cylinder;
- Do not turn any lights or electrical devices on or off;
- Open all windows and doors to increase ventilation;
- If alarm stops it is necessary to detect the issue and remove the cause for the leakage;
- If the alarm continues and the cause is not evident or possible to eliminate leave the room immediately and call the emergency service.

**1.4 Fault mode** - A fault condition status is indicated in the following scenarios:

- Fault in the auxiliary power supply to the 71CNG detector - the **green** and **yellow** LEDs of the 71CNG are OFF and a Fault message "Power loop isolator ON" is in the IFS7002 panel's menu "Lists>Faults>Total";
- Fault in the semiconductor gas sensor – the **yellow** LED is continuously On.

## INSTALLATION

### 1. Mechanical installation

Remove the front cover of the cabinet and follow the Mechanical diagram on fig.2

Verify that the semiconductor sensor component is not damaged after the 71CNG detector is unpacked.

Verify that data written on the box are the same as the kind of gas applied in the protected premises.

Follow the summary and wiring applied in point. 2 "Connection diagram"

The detector should be installed vertically at the wall – LEDs indicators are in the top-side of the cabinet, the inlet openings are on the bottom side of the cabinet.

**Design rules:**

- min. 10 cm. distance above highest window or door opening;
- max 15 cm. distance to ceiling;
- installed on the opposite wall against the possible gas sources - i.e. ovens, boilers, etc;
- not to be installed behind barriers which would delay the detection of gas;
- not to be installed near fans or ventilation;
- not to be installed in ambient temperature below -5°C or above +40°C.

**2. CONNECTION DIAGRAM**

The cables are connected to screw terminal blocks ( fig.3).

3.1. Terminal bus

3.1.1. Address Loop:

- Terminal 1 – address loop shield
- Terminal 2 – address loop "+"
- Terminal 3 – address loop "-"
- Terminal 4 – address loop "-"
- Terminal 5 – address loop "+"
- Terminal 6 – address loop shield

Note: Loop input and Loop output is not required to be followed while the address loop is wired.

3.1.2. Auxiliary Power Supply:

Terminal 7 & 10 : both terminals are common and dedicated for aux. power supply "+"

Terminal 8 & 9 : both terminals are common and dedicated for aux. power supply "-"

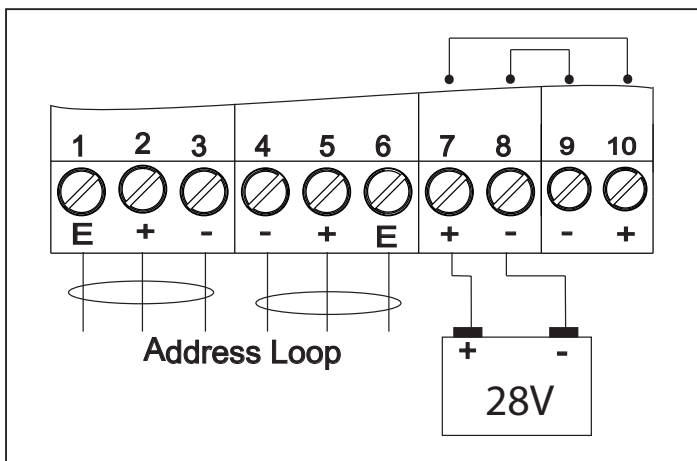

Fig.3  
Terminal bus

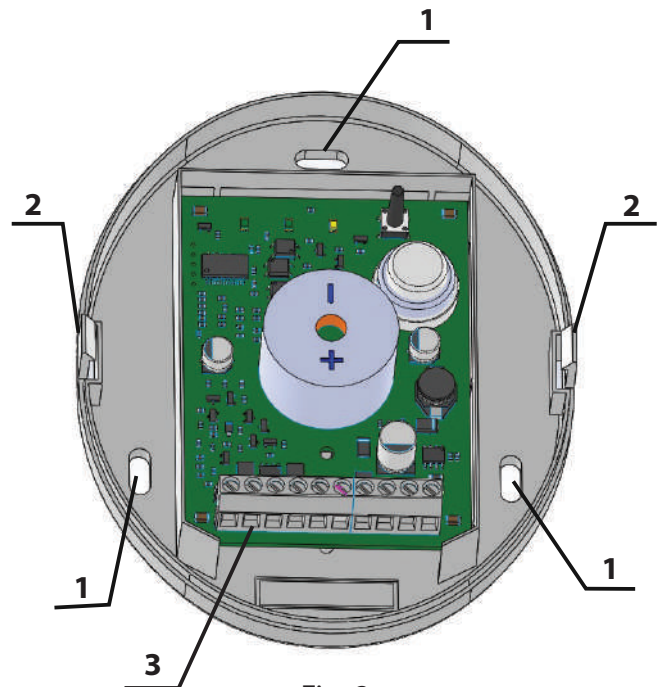

Fig. 2  
Mechanical diagram

- 1. Screw fixer
- 2. Holder
- 3. Terminal bus

## **71CNG START-UP IN THE IFS7000**

1. The 71CNG is auto-addressed with the common "Setup>Initialization>Clean Initialization" procedure from the display of the IFS7002 fire control panel;
2. The 71CNG could be recognized and verified with procedure "Setup>Initialization>Check" - both LEDs will be continuous ON;  
**Note:** Be aware that the 71CNG device is recognized as a Conventional Interface module FD7201S;
3. On system start-up the 71CNG device will warm-up for 120 sec. before being in Duty mode with both LEDs flash on a period of 16 sec;
4. From menu "Lists > Devices status" the panel will read the online status of the device. The value of the conventional line is the ADC measurement of the semi-conductor sensor built-in the 71CNG.
5. In Duty mode press the Test button of the 71CNG in order to make LED test of the detector;  
**Note:** Do not hold the button for more than 5 seconds

## **CONTENTS OF DELIVERY:**

Gas Detector 71CNG	- 1 pc
Package box	- 1 pc
Leaflet	- 1 pc
Label for operation period	- 1 pc

## **SERVICE SCHEDULE**

The built-in the 71CNG semiconductor sensor component is with lifetime of 5 years. After the detector is installed then the maintenance company must take care to stick and mark the visible area of the cabinet (refer the "Leaflet") with the provided "Label for operation period". The operation period of the 71CNG is out of service as soon as the lifetime of the semiconductor sensor component is over. In case that the 71CNG is out of its marked operation period, then contact the maintenance company. The semiconductor sensor component/technology does not stand a gas sensing over 40% of the LEL. A gas with methane saturation over 40% of the LEL will cause the malfunction of the sensor. An instance of gas over the 40% LEL reduces the life of the semiconductor sensor. The 71CNG gas detector is tested only with dedicated test equipment. Never clean the device with chemical products. If necessary to clean then disconnect the cables and use use humid towel.

## **WARRANTY**

Installation and maintenance must be done from qualified and/or authorised technician, only with guarantee of the origin of the spare parts. The warranty period is 36 months from the date of sale, providing that the installation requirements have been observed. The manufacturer does not bear warranty liabilities for damages caused through accidental mechanical damage, misuse, adaptation or modification after production.

*UniPOS wishes you a successful work !*

47, "San Stefano" str., 5800 Pleven, Bulgaria  
e-mail: office\_pleven@unipos-bg.com

Office building UniPOS  
1 " Efr..N.Paskalev" str., Mladost 1, Sofia 1784, Bulgaria  
tel./fax: +359 2 974 44 69, +359 2 974 39 25  
e-mail: office\_sofia@unipos-bg.com  
[www.unipos-bg.com](http://www.unipos-bg.com)