

# DS-K4T100-UX Series

## Accessories of Electric Bolt

### DS-K4T100-U1

### Lower U-bracket of Electric Bolt. for Using with DS-K4T100

- The bracket is made up of aluminum alloy
- It is suitable for fully frameless glass door;
- The door opens both sides at the angle of 180°;
- The thickness of the glass is 10~15mm (0.39~0.59");
- The weight of the product is 0.27kg (0.60lb)



### DS-K4T100-U1

### Installation and Dimension

#### Installation

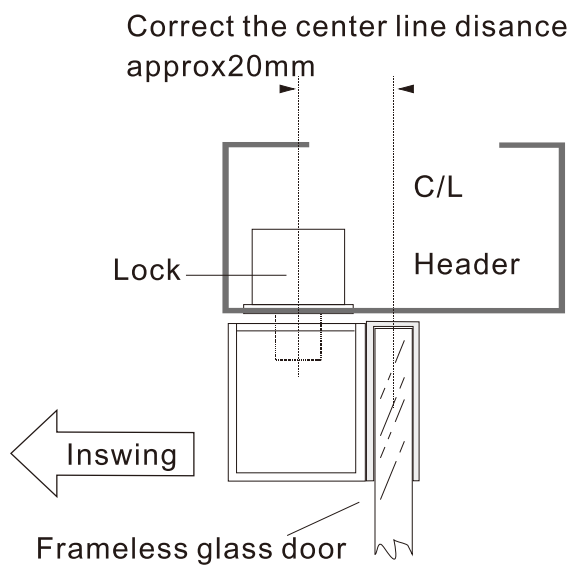

Bracket Section View

#### Dimension

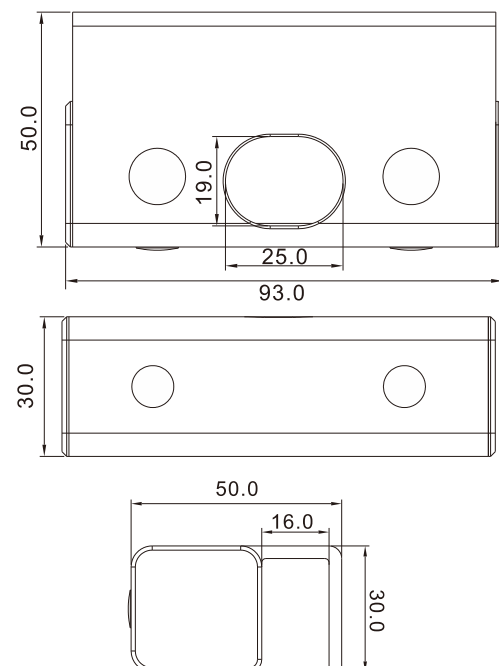

**DS-K4T100-U2****Upper and lower U-bracket of Electric Bolt, for Using with DS-K4T100**

- The bracket is made up of aluminum alloy;
- The dimension (L×W×H) of the bracket is:  
205×58×46mm (8.07×2.28×1.81")
- It is suitable for fully frameless glass door;
- The door opens both sides at angle of 180°;
- The thickness of the glass is 10~15mm (0.39~0.59");
- The weight of the product is 1.3kg.(2.87lb)

**DS-K4T100-U1****Installation**